



US009741359B2

(12) **United States Patent**
Cheung et al.

(10) **Patent No.:** **US 9,741,359 B2**
(45) **Date of Patent:** ***Aug. 22, 2017**

(54) **HYBRID AUDIO DELIVERY SYSTEM AND METHOD THEREFOR**

(71) Applicant: **IpVenture, Inc.**, Los Altos, CA (US)

(72) Inventors: **Kwok Wai Cheung**, Tai Po (HK);
Peter P. Tong, Mountain View, CA (US);
C. Douglass Thomas, Saratoga, CA (US)

(73) Assignee: **IpVenture, Inc.**, Los Altos, CA (US)

(*) Notice: Subject to any disclaimer, the term of this patent is extended or adjusted under 35 U.S.C. 154(b) by 16 days.
This patent is subject to a terminal disclaimer.

(21) Appl. No.: **14/482,049**

(22) Filed: **Sep. 10, 2014**

(65) **Prior Publication Data**
US 2014/0376745 A1 Dec. 25, 2014

Related U.S. Application Data
(63) Continuation of application No. 12/930,344, filed on Jan. 4, 2011, now Pat. No. 8,849,185, which is a (Continued)

(51) **Int. Cl.**
H04R 3/12 (2006.01)
G10L 21/0208 (2013.01)
(Continued)

(52) **U.S. Cl.**
CPC **G10L 21/0208** (2013.01); **H04R 1/403** (2013.01); **H04R 25/405** (2013.01);
(Continued)

(58) **Field of Classification Search**
CPC H04R 1/403; H04R 25/405; H04R 3/12; H04R 2201/023; H04R 2217/03; G10L 21/0208; H04M 1/6033; H04M 1/6041
(Continued)

(56) **References Cited**

U.S. PATENT DOCUMENTS

3,942,139 A 3/1976 Cooper et al.
3,974,335 A 8/1976 Blackledge
(Continued)

FOREIGN PATENT DOCUMENTS

JP 01109898 A 4/1989
KR 2001-0091117 A 10/2001

OTHER PUBLICATIONS

Office Action for U.S. Appl. No. 10/826,529, dated Jan. 3, 2007.
(Continued)

Primary Examiner — Melur Ramakrishnaiah

(57) **ABSTRACT**

Methods and systems to produce audio output signals from audio input signals. In one embodiment, a first portion of the audio input signals can be pre-processed, with the output used to modulate ultrasonic carrier signals, thereby producing modulated ultrasonic signals. The modulated ultrasonic signals can be transformed into a first portion of the audio output signals, which is directional. Based on a second portion of the audio input signals, a standard audio speaker can output a second portion of the audio output signals. Another embodiment further produces distortion compensated signals based on the pre-processed signals. The distortion compensated signals can be subtracted from the second portion of the audio input signals to generate inputs for the standard audio speaker to output the second portion of the audio output signals. In yet another embodiment, noise can be added during pre-processing of the first portion of the audio input signals.

51 Claims, 31 Drawing Sheets

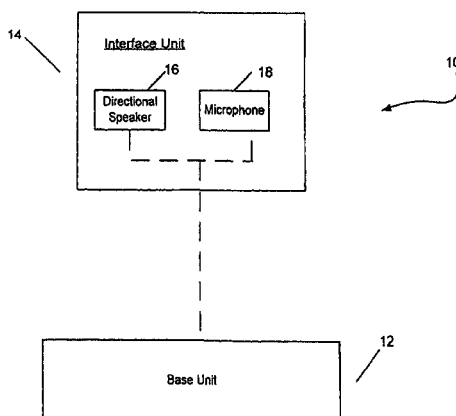

Related U.S. Application Data

continuation-in-part of application No. 12/462,601, filed on Aug. 6, 2009, now Pat. No. 8,208,970, which is a continuation of application No. 11/893,835, filed on Aug. 16, 2007, now Pat. No. 7,587,227, which is a continuation of application No. 10/826,529, filed on Apr. 15, 2004, now Pat. No. 7,269,452.

(60) Provisional application No. 61/335,361, filed on Jan. 5, 2010, provisional application No. 60/462,570, filed on Apr. 15, 2003, provisional application No. 60/469,221, filed on May 12, 2003, provisional application No. 60/493,441, filed on Aug. 8, 2003.

(51) **Int. Cl.**
H04R 1/40 (2006.01)
H04R 25/00 (2006.01)

(52) **U.S. Cl.**
 CPC *H04R 3/12* (2013.01); *H04R 2201/023* (2013.01); *H04R 2217/03* (2013.01)

(58) **Field of Classification Search**
 USPC 381/98, 150; 455/3.06, 94.1, 213, 350, 455/41.2, 566.1, 569.1
 See application file for complete search history.

(56) **References Cited**

U.S. PATENT DOCUMENTS

4,006,308 A 2/1977 Pongsen
 4,128,738 A 12/1978 Gallery
 4,292,679 A 9/1981 Kondo et al.
 4,476,571 A 10/1984 Tokumo et al.
 4,622,440 A 11/1986 Slavin
 4,625,318 A 11/1986 Snyder
 4,823,908 A 4/1989 Tanaka et al.
 4,955,729 A 9/1990 Marx
 5,313,663 A 5/1994 Norris
 5,321,758 A 6/1994 Charpentier et al.
 5,357,578 A 10/1994 Taniishi
 5,450,494 A 9/1995 Okubo et al.
 5,481,616 A 1/1996 Freadman
 5,495,534 A 2/1996 Inanaga et al.
 5,519,781 A 5/1996 Kukurudza
 5,526,411 A 6/1996 Krieter
 5,572,575 A 11/1996 Yamamoto et al.
 5,588,041 A 12/1996 Meyer et al.
 5,648,824 A 7/1997 Dunn et al.
 5,666,424 A 9/1997 Fosgate et al.
 5,682,157 A 10/1997 Asmussen et al.
 5,764,595 A 6/1998 Power
 5,764,782 A 6/1998 Hayes
 5,777,665 A 7/1998 McNelley et al.
 5,793,875 A 8/1998 Lehr et al.
 5,802,190 A 9/1998 Ferren
 5,819,183 A 10/1998 Voroba et al.
 5,828,768 A 10/1998 Eatwell et al.
 5,835,732 A 11/1998 Kikinis et al.
 5,870,484 A 2/1999 Greenberger
 5,943,430 A 8/1999 Saitoh
 6,011,855 A 1/2000 Selfridge et al.
 6,041,657 A 3/2000 Sutherland
 6,058,315 A 5/2000 Clark
 6,086,541 A 7/2000 Rho
 6,151,398 A 11/2000 Norris
 6,163,711 A 12/2000 Juntunen et al.
 6,169,813 B1 1/2001 Richardson et al.
 6,243,472 B1 6/2001 Bilan et al.
 6,259,731 B1 7/2001 Dent et al.
 6,275,596 B1 8/2001 Fretz et al.
 6,279,946 B1 8/2001 Johnson et al.
 6,322,521 B1 11/2001 Hou
 6,363,139 B1 3/2002 Zurek et al.
 6,445,804 B1 9/2002 Hirayanagi

6,453,045 B1 9/2002 Zurek et al.
 6,477,258 B1 11/2002 Watson et al.
 6,484,040 B1 11/2002 Wang
 6,496,205 B1 12/2002 White et al.
 6,498,970 B2 12/2002 Colmenarez et al.
 6,512,826 B1 1/2003 Kim
 6,535,612 B1 3/2003 Croft, III et al.
 6,556,687 B1 4/2003 Manabe
 6,584,205 B1 6/2003 Croft, III et al.
 6,591,085 B1 7/2003 Grady
 6,594,367 B1 7/2003 Marash et al.
 6,631,196 B1 10/2003 Taenzer et al.
 6,643,377 B1 11/2003 Takahashi et al.
 6,650,755 B2 11/2003 Vaudrey et al.
 6,671,494 B1 12/2003 James
 6,678,381 B1 1/2004 Manabe
 6,771,785 B2 8/2004 Pompei
 6,895,261 B1 5/2005 Palamides
 6,914,991 B1 7/2005 Pompei
 7,013,009 B2 3/2006 Warren
 7,016,504 B1 3/2006 Shennib
 7,062,050 B1 6/2006 Pompei
 7,106,180 B1 9/2006 Pompei
 7,269,452 B2 9/2007 Cheung
 7,376,236 B1 5/2008 Norris et al.
 7,388,962 B2 6/2008 Cheung
 7,587,227 B2 9/2009 Cheung et al.
 7,596,228 B2 9/2009 Pompei
 7,657,044 B2 2/2010 Pompei
 7,801,570 B2 9/2010 Cheung et al.
 8,208,970 B2 6/2012 Cheung et al.
 8,582,789 B2 11/2013 Cheung et al.
 8,849,185 B2 9/2014 Cheung et al.
 8,953,821 B2 2/2015 Pompei
 2001/0007591 A1 7/2001 Pompei
 2001/0038698 A1 11/2001 Breed et al.
 2001/0055397 A1 12/2001 Norris et al.
 2002/0005777 A1 1/2002 Rodewald et al.
 2002/0008718 A1 1/2002 Obradovich
 2002/0012441 A1 1/2002 Matsunaga et al.
 2002/0048382 A1 4/2002 Hou
 2002/0048385 A1 4/2002 Rosenberg
 2002/0054689 A1 5/2002 Zhang et al.
 2002/0090099 A1 7/2002 Hwang
 2002/0090103 A1 7/2002 Calisto, Jr.
 2002/0136414 A1 9/2002 Jordan et al.
 2002/0141599 A1 10/2002 Trajkovic et al.
 2002/0149705 A1 10/2002 Allen et al.
 2002/0183648 A1 12/2002 Hou
 2002/0191807 A1 12/2002 Asada et al.
 2003/0009248 A1 1/2003 Wiser et al.
 2003/0026439 A1 2/2003 Yamamoto et al.
 2003/0035552 A1 2/2003 Kolano et al.
 2003/0091200 A1 5/2003 Pompei
 2003/0092377 A1 5/2003 Hill
 2003/0118198 A1 6/2003 Croft, III et al.
 2003/0156495 A1 8/2003 Haase et al.
 2003/0174242 A1 9/2003 Carmi et al.
 2003/0182104 A1 9/2003 Muesch
 2004/0005069 A1 1/2004 Buck
 2004/0042615 A1* 3/2004 Scholte H04M 1/6033
 379/387.01
 2004/0052387 A1 3/2004 Norris et al.
 2004/0114770 A1 6/2004 Pompei
 2004/0114772 A1 6/2004 Zlotnick
 2004/0170086 A1 9/2004 Mayer et al.
 2004/0202339 A1 10/2004 O'Brien, Jr. et al.
 2004/0204168 A1 10/2004 Laurila
 2004/0208324 A1 10/2004 Cheung et al.
 2004/0208325 A1 10/2004 Cheung et al.
 2004/0208333 A1 10/2004 Cheung et al.
 2004/0209654 A1 10/2004 Cheung et al.
 2005/0009583 A1 1/2005 Cheung et al.
 2006/0210090 A1 9/2006 Shennib
 2006/0233404 A1 10/2006 Croft et al.
 2006/0291667 A1 12/2006 Watanabe et al.
 2007/0189548 A1 8/2007 Croft, III
 2007/0211574 A1 9/2007 Croft, III
 2007/0287516 A1 12/2007 Cheung

(56)

References Cited

U.S. PATENT DOCUMENTS

2008/0279410	A1	11/2008	Cheung et al.	
2009/0298430	A1	12/2009	Cheung et al.	
2010/0080409	A1*	4/2010	Xu	B06B 1/0644 381/396
2011/0103614	A1	5/2011	Cheung et al.	

OTHER PUBLICATIONS

Notice of Allowance for U.S. Appl. No. 10/826,529 dated Jun. 12, 2007.

Supplemental Notice of Allowance for U.S. Appl. No. 10/826,529, dated Jul. 30, 2007.

Office Action for U.S. Appl. No. 11/893,835, dated Oct. 21, 2008.

Notice of Allowance for U.S. Appl. No. 11/893,835, dated May 19, 2009.

Supplemental Notice of Allowance for U.S. Appl. No. 11/893,835, dated Jun. 8, 2009.

Supplemental Notice of Allowance for U.S. Appl. No. 11/893,835, dated Jun. 15, 2009.

Office Action for U.S. Appl. No. 12/462,601, dated Nov. 9, 2011.

Notice of Allowance for U.S. Appl. No. 12/462,601, dated Mar. 29, 2012.

Office Action for U.S. Appl. No. 12/930,344, dated Mar. 5, 2014.

Notice of Allowance for U.S. Appl. No. 12/930,344, dated Jun. 3, 2014.

Office Action, re: CN 200480010388.8, Chinese Patent Office, Apr. 17, 2009, 8 pages.

Second Office Action re: CN200480010388.8 Chinese Patent Office, Sep. 4, 2009, 6 pages.

Third Office Action re: CN200480010388.8 Chinese Patent Office, Jan. 22, 2010, 9 pages.

Fourth Office Action re: CN200480010388.8 Chinese Patent Office, Jul. 25, 2012, 4 pages.

Fifth Office Action re: CN200480010388.8 Chinese Patent Office, Oct. 26, 2012, 5 pages.

PCT International Search Report, Re: PCT/US04/11972, Jan. 31, 2005.

PCT Written Opinion of the International Searching Authority, Re: PCT/US04/11972, Jan. 31, 2005.

American Technology Corporation, HyperSonic Sound, Jan. 22, 2002, www.atcsd.com.

American Technology Corporation, "Technology Introduction," 2001, pp. 1-19.

American Technology Corporation, "Theory, History, and the Advancement of Parametric Loudspeakers—A Technology Overview," White Paper, 2002, pp. 1-27.

American Technology Corporation, "HSS Directed Audio Sound System, Model Series: 220," Product Information, 2003.

American Technology Corporation, "Technology Licensing—HyperSonic Sound," 2003, pp. 1-3.

Aoki, K. et al., "Parametric Loudspeaker—Applied Examples," Electronics and Communications in Japan, Part 3, vol. 77, No. 1, 1994, pp. 64-74.

Aoki, K. et al., "Self-demodulation of a plane-wave—Study on primary wave modulation for wideband signal transmission," J. Acoust. Soc. Jpn., pp. 349-356, 1984 (with English abstract).

Averkiou, M.A. et al., "Self-demodulation of amplitude- and frequency-modulated pulses in a thermoviscous fluid," The Journal of the Acoustical Society of America, 94(5), Nov. 1993, pp. 2876-2883.

Baker, A. C., "Nonlinear pressure fields due to focused circular apertures," The Journal of the Acoustical Society of America, 91(2), Feb. 1992, pp. 713-717.

Bennett, M. B., et al., "Parametric array in air," The Journal of the Acoustical Society of America, vol. 57, No. 3, Mar. 1975, pp. 562-568.

Berktag, H.O., "Possible Exploitation of Non-Linear Acoustics in Underwater Transmitting Applications," J. Sound Vib. (1965) 2(4), 435-461.

Berntsen, J. et al., "Interaction of sound waves. Part IV: Scattering of sound by sound," The Journal of the Acoustical Society of America, 86(5), Nov. 1989, pp. 1968-1983.

Berntsen, J. et al., "Nearfield of a large acoustic transducer. Part IV: Second harmonic and sum frequency radiation," The Journal of the Acoustical Society of America, 75(5), May 1984, pp. 1383-1391.

Blackstock, David T., "Audio Application of the Parametric Array," J. Acoust. Soc. Am, vol. 102, No. 5, Pt. 2, Nov. 1997, p. 3106.

Brain, Marshall, How USB Ports Work, Oct. 11, 2002, www.howstuffworks.com/usb.

Darvennes, C. M., et al., "Effects of absorption on the nonlinear interaction of sound beams," The Journal of the Acoustical Society of America, 89(3), Mar. 1991, pp. 1028-1036.

Davy, B. A., "Acoustic Self-demodulation of Pre-distorted Pulsed Carriers," Masters' Thesis, University of Texas Austin, 1972, title page, pp. i-ix, and 1-57.

Darvennes, C. M., et al., "Scattering of sound by sound from two Gaussian beams," The Journal of the Acoustical Society of America, 87(5), May 1990, pp. 1955-1964.

Druyvesteyn, W. F., et al., "Personal Sound," J. Audio Eng. Soc., vol. 45, No. 9, Sep. 1997, pp. 685-701.

Garrett, G. et al., "Nearfield of a large acoustic transducer, Part II: Parametric radiation," The Journal of the Acoustical Society of America, 74(3), Sep. 1983, pp. 1013-1020.

Garrett, G., et al., "Nearfield of a large acoustic transducer. Part III: General results," The Journal of the Acoustical Society of America, 75(3), Mar. 1984, pp. 769-779.

Gol'dberg, Z.A., "Certain Second-Order Quantities in Acoustics," Sov Phys Acoust, vol. 3, 1957, pp. 157-162.

Greenspan, M., "Piston radiator: Some extensions of the theory," The Journal of the Acoustical Society of America, 65(3), Mar. 1979, pp. 608-621.

Havelock, D. I., "Directional Loudspeakers Using Sound Beams," J. Audio Eng. Soc., vol. 48, No. 10, Oct. 2000, pp. 908-916.

Holosonic Research Labs, Inc. 2002, "Audio Spotlight—Put sound where you want it," www.holosonics.com/technology.html (downloaded Jan. 18, 2004).

Kamakura, T. et al., "Development of Parametric Loudspeaker for Practical Use", Proceedings of the 10th International Symposium on Nonlinear Acoustics, pp. 147-150, 1984.

Kamakura, T. et al., "Suitable Modulation of the Carrier Ultrasound for a Parametric Loudspeaker," Acustica, vol. 73 (1991), pp. 215-217.

Kamakura, T. et al., "Harmonic generation in finite amplitude sound beams from a rectangular aperture source," The Journal of the Acoustical Society of America, 91(6), Jun. 1992, pp. 3144-3151.

Kamakura, T., et al., "Nonlinearly generated spectral components in the nearfield of a directive sound source," The Journal of the Acoustical Society of America, 85(6), Jun. 1989, pp. 2331-2337.

Kim, W. et al., "Audio Application of the Parametric Array—Implementation through a Numerical Model," presented at the 113th Convention of the Audio Engineering Society (AES), paper 5652, Oct. 2002, pp. 1-16.

Kim, Y.W. et al., "Novel Preprocessing Technique to Improve Harmonic Distortion in Airborne Parametric Array," ICSP '02 Proceedings, IEEE 2002, pp. 1815-1818.

Kite, T.D., et al., "Parametric Array in Air: Distortion Reduction by Preprocessing," Proceedings of the 16th International Congress on Acoustics and the 135th Meeting of the Acoustical Society of America, Seattle, WA, Jun. 1998, pp. 1091-1092.

Kuznetsov, V. P., "Equations of Nonlinear Acoustics," Soviet Physics—Acoustics, vol. 16, No. 4, Apr.-Jun. 1971, pp. 467-470.

Lawton, B. W., "Damage to human hearing by airborne sound of a very high frequency or ultrasonic frequency," Institute of Sound and Vibration Research, Contract Research Report 343/2001, 2001, pp. 1-77.

Lucas, B. G., et al., "Field of a parametric focusing source," The Journal of the Acoustical Society of America, 73 (6), Jun. 1983, pp. 1966-1971.

(56)

References Cited

OTHER PUBLICATIONS

Lucas, B. G., et al., "The field of a focusing source," *The Journal of the Acoustical Society of America*, 72(4), Oct. 1982, pp. 1289-1296.

Maney, K., "Sound technology turns the way you hear on its ear," *USA Today*, May 2003, pp. 1-4.

Marculescu, D. et al., "Ready to Ware," *IEEE Spectrum*, Oct. 2003, pp. 28-32.

Meyer, J., "Microphone Array for Hearing Aids taking into Account the Scattering of the Head," 2001 IEEE Workshop on Applications of Signal Processing to Audio and Acoustics, Oct. 21-24, 2001, pp. 27-30.

Muir, T.G., et al., "Parametric Acoustic Transmitting Arrays," *The Journal of the Acoustical Society of America*, vol. 52, No. 5, Part 2, 1972, pp. 1481-1486.

Nextel Communications, *i60c Phone User's Guide*, 2002, pp. 6, 65, 66, 135-137.

Nextel i60c Phone Details, <http://nextelonline.nextel.com>, downloaded Apr. 22, 2003, pp. 1-2.

Nextel-Direct Connect, <http://nextelonline.nextel.com/services/directconnect-popup.html>, downloaded Apr. 22, 2003, p. 1.

Palm™ m515 Handheld, Palm Store of Yahoo! Shopping, downloaded Apr. 23, 2003, pp. 1-2.

Palm™ PalmModem® Connectivity Kit, Palm Store of Yahoo! Shopping, downloaded Apr. 23, 2003, pp. 1-2.

Palm™ Tungsten™ C Handheld, Palm Store of Yahoo! Shopping, downloaded Apr. 23, 2003, pp. 1-3.

Palm™ Zire™ 71 Handheld, Palm Store of Yahoo! Shopping, downloaded Apr. 23, 2003, pp. 1-3.

Pompei, F. J., "The Use of Airborne Ultrasonics for Generating Audible Sound Beams," *J. Audio Eng. Soc.*, vol. 47, No. 9, Sep. 1999, pp. 726-731.

"The Cookie-Size Concert Hall," *Business Week*, Dec. 2, 1996, 5 pages.

Tjøtta, J. N. et al., "Propagation and interaction of two collinear finite amplitude sound beams," *The Journal of the Acoustical Society of America*, 88(6), Dec. 1990, pp. 2859-2870.

Vyas, A. L., et al., "Design Considerations of Parametric Arrays," *IEEE Proceedings of the 1998 International Symposium on Underwater Technology*, Apr. 15-17, 1998, pp. 98-102.

Westervelt, P.J., "Parametric Acoustic Array," *The Journal of the Acoustical Society of America*, vol. 35, No. 4, Apr. 1963, pp. 535-537.

Yoneyama, M., et al., "The audio spotlight: An application of nonlinear interaction of sound waves to a new type of loudspeaker design," *The Journal of the Acoustical Society of America*, 73(5), May 1983, pp. 1532-1536.

Zabolotskaya, E. A., et al., "Quasi-plane Waves in the Nonlinear Acoustics of Confined Beams," *Soviet Physics—Acoustics*, vol. 15, No. 1, Jul.-Sep. 1969, pp. 35-40.

Zemanek, J. "Beam Behavior within the Nearfield of a Vibrating Piston," *The Journal of the Acoustical Society of America*, vol. 42, No. 1 (Part 2), 1971, pp. 181-191.

* cited by examiner

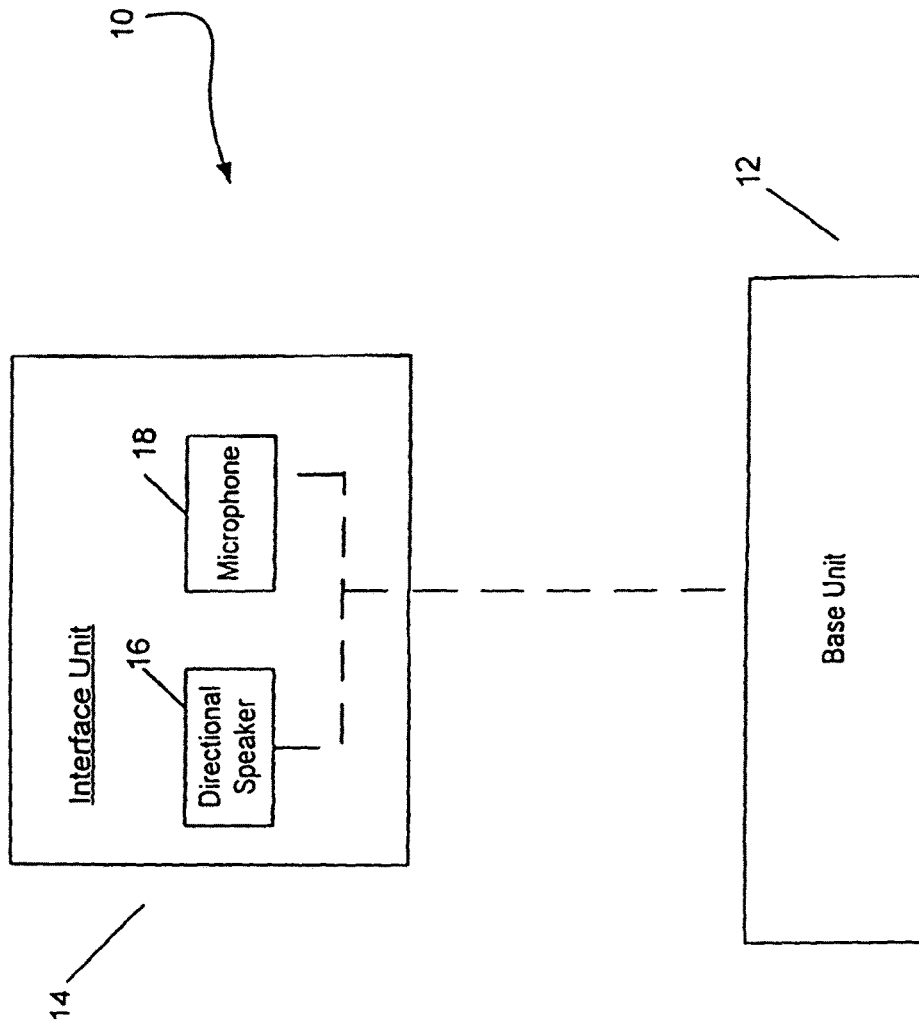

FIG. 1

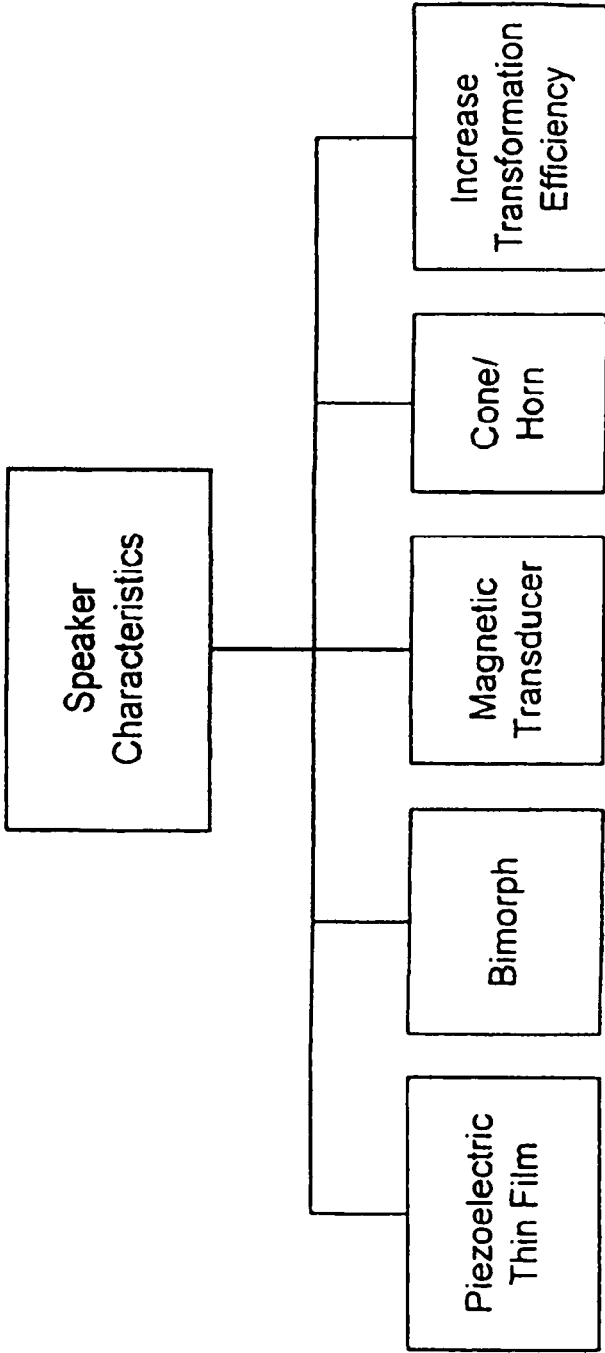

FIG. 2

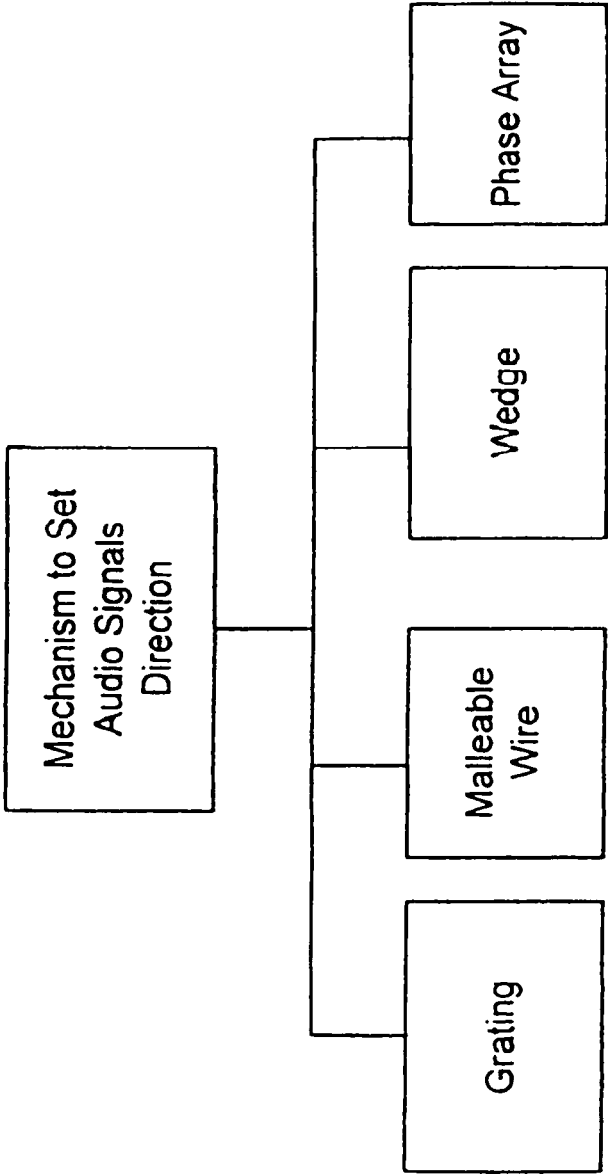

FIG. 3

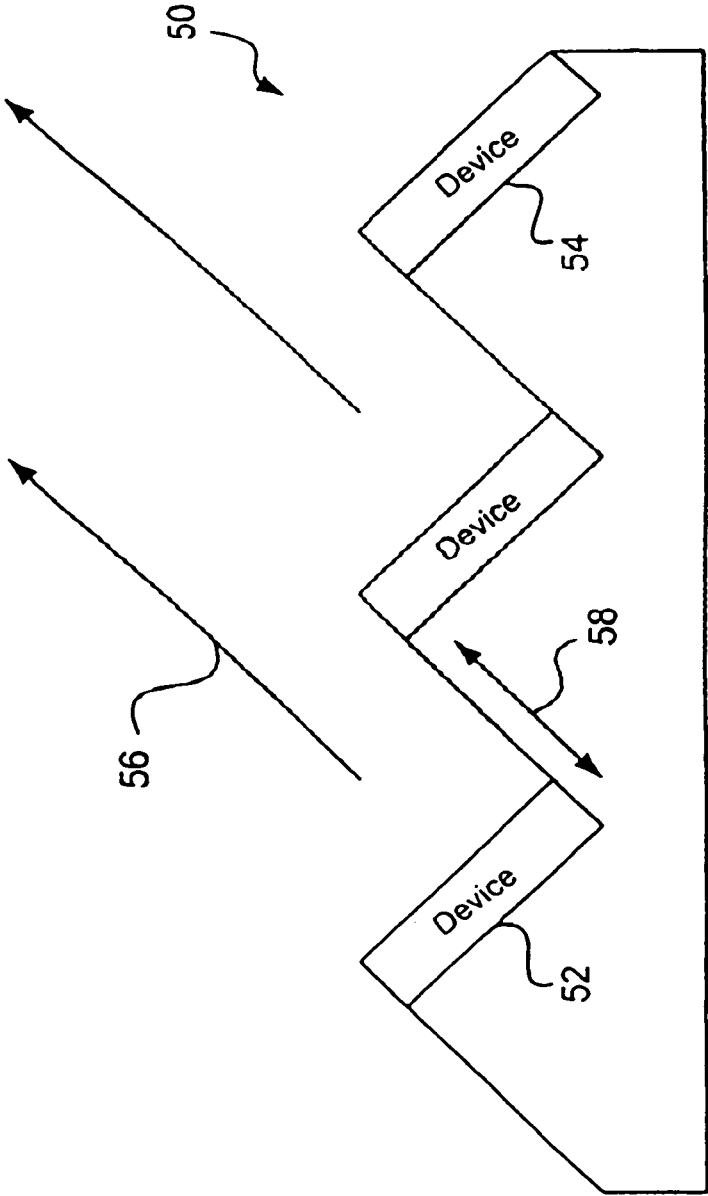

FIG. 4A

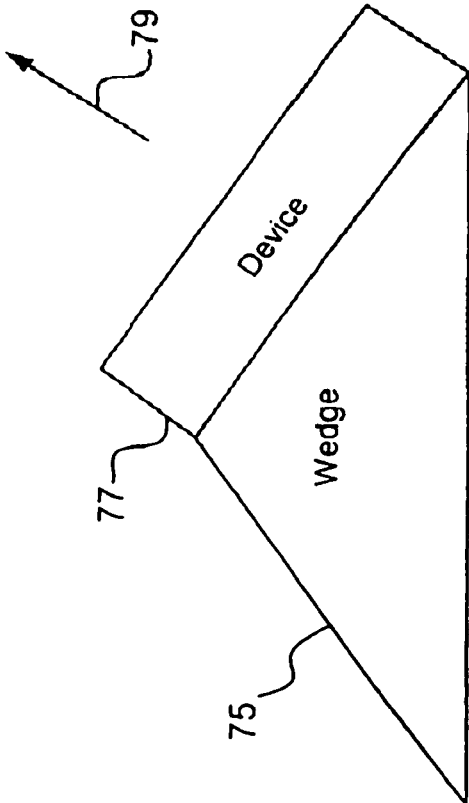

FIG. 4B

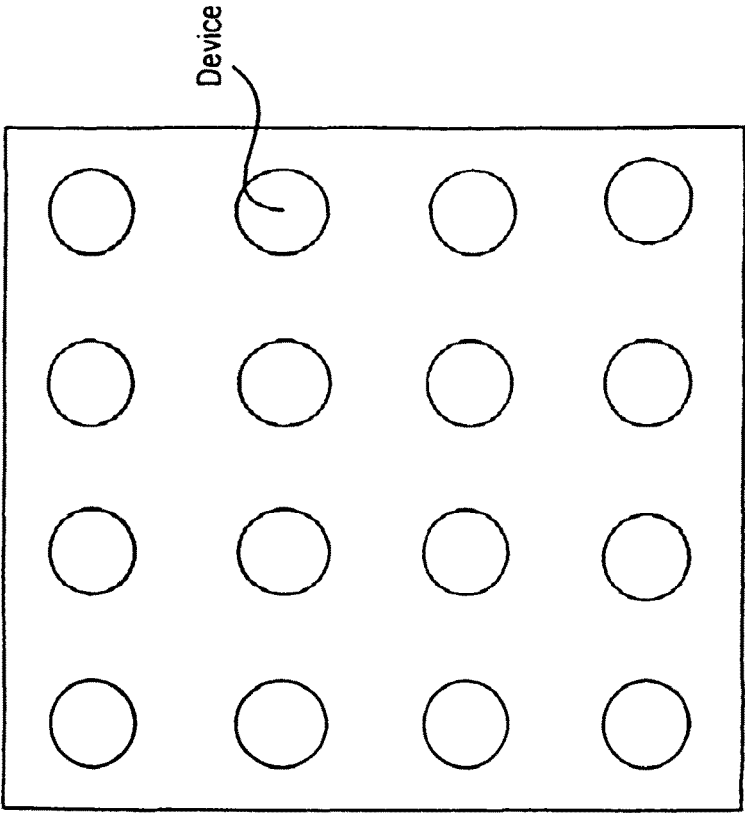

FIG. 5

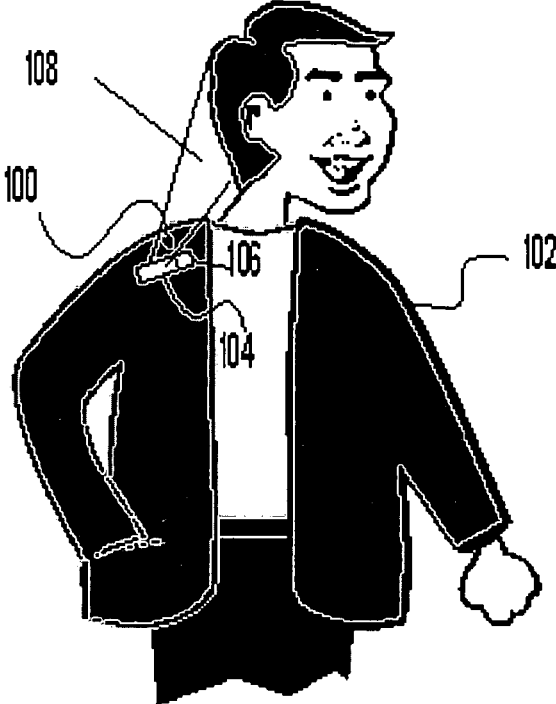

FIG. 6

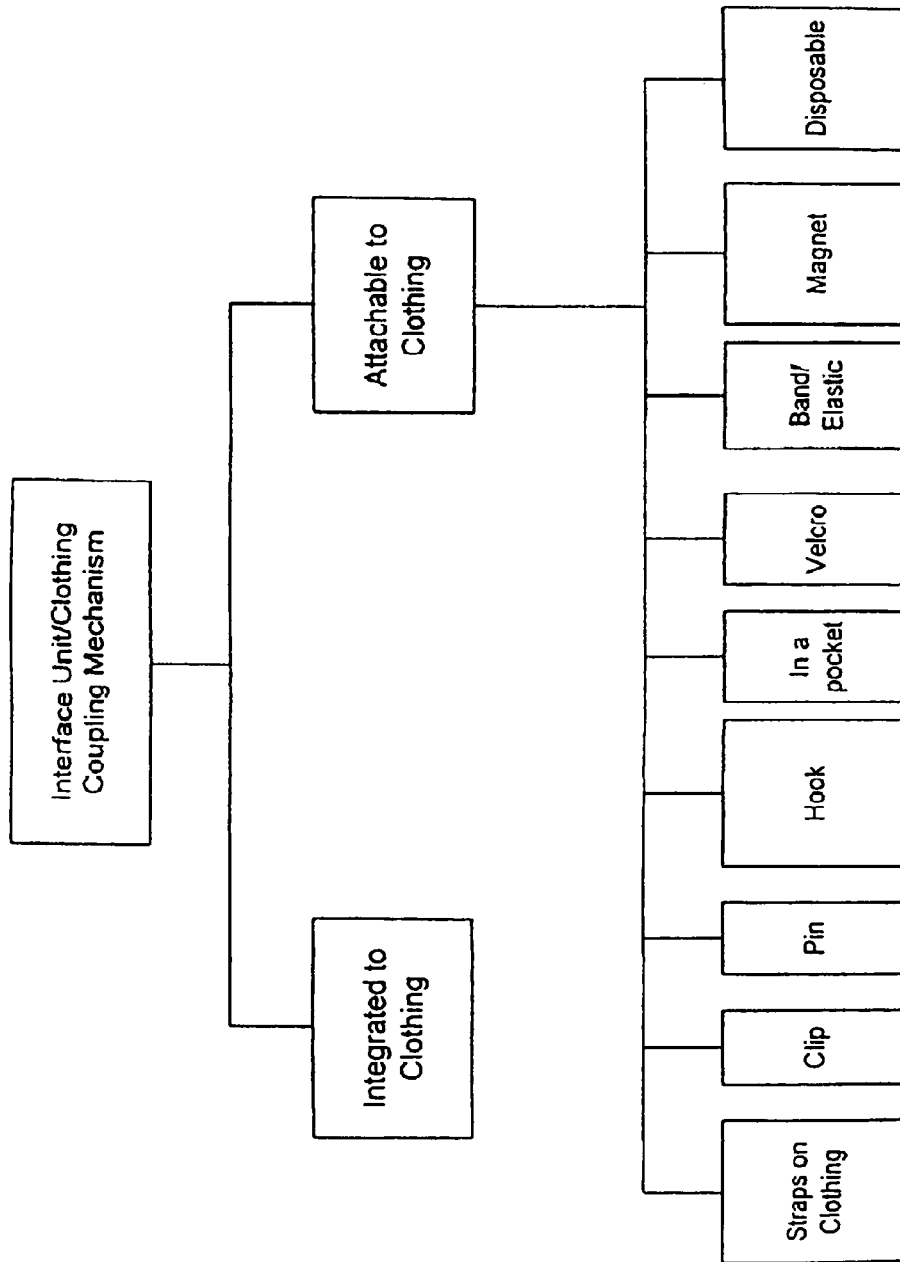

FIG. 7

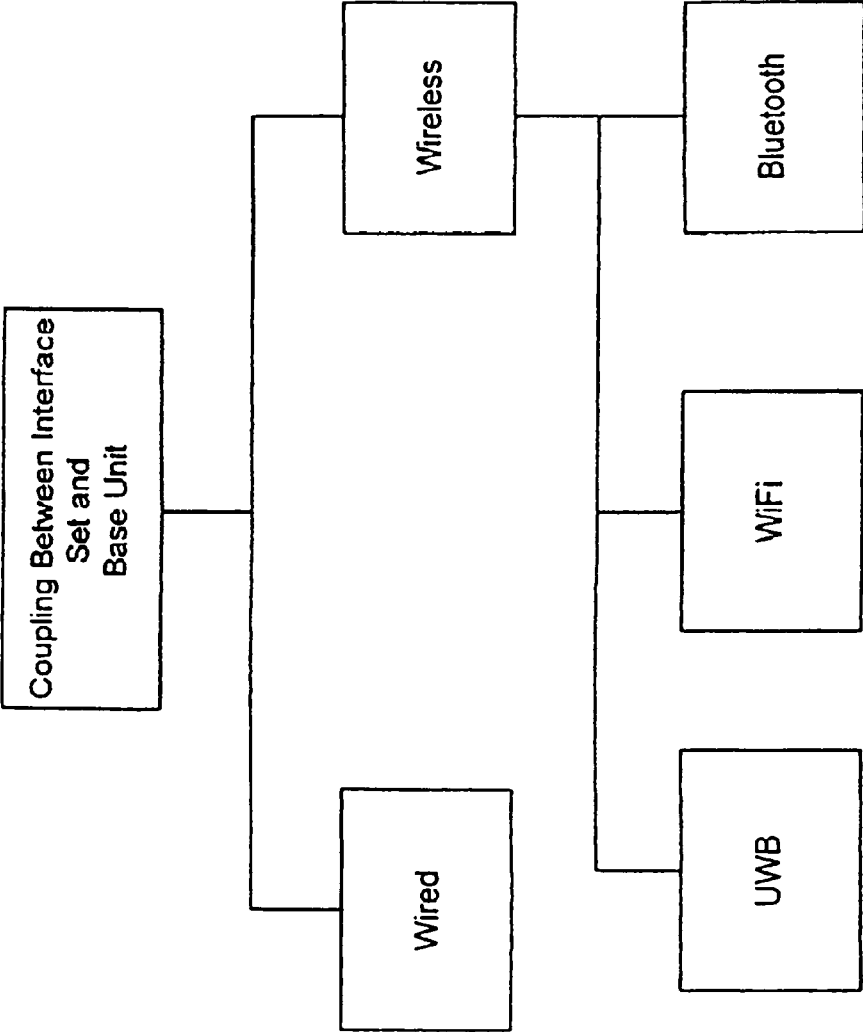

FIG. 8

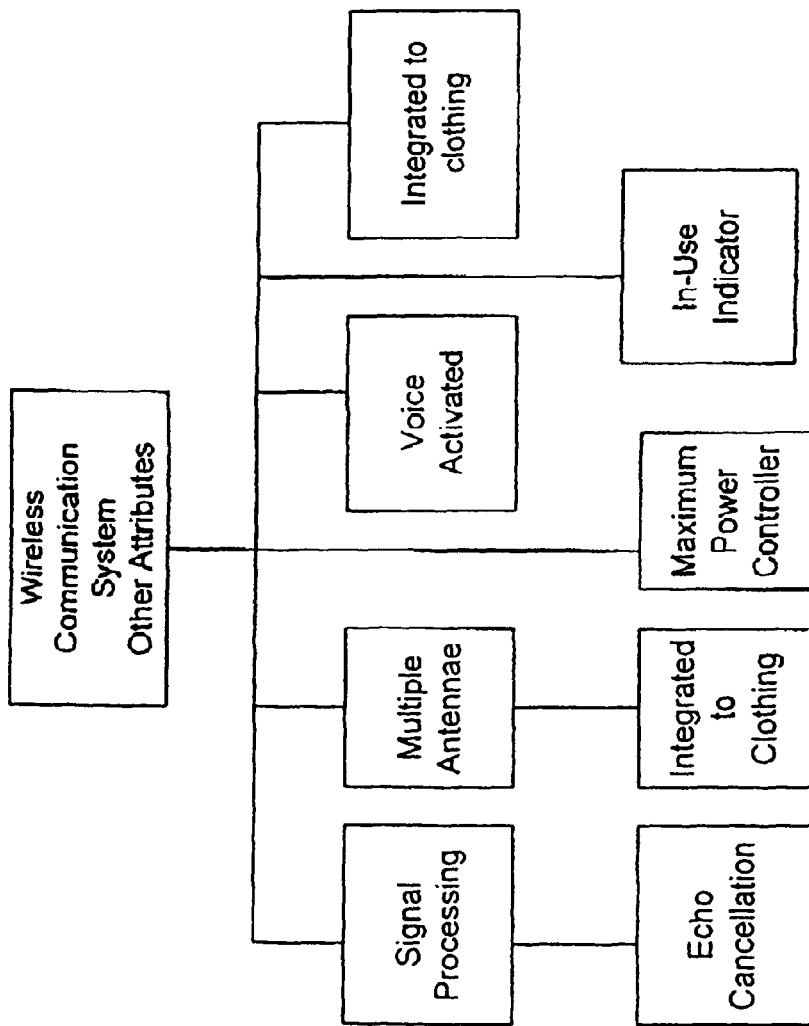

FIG. 9

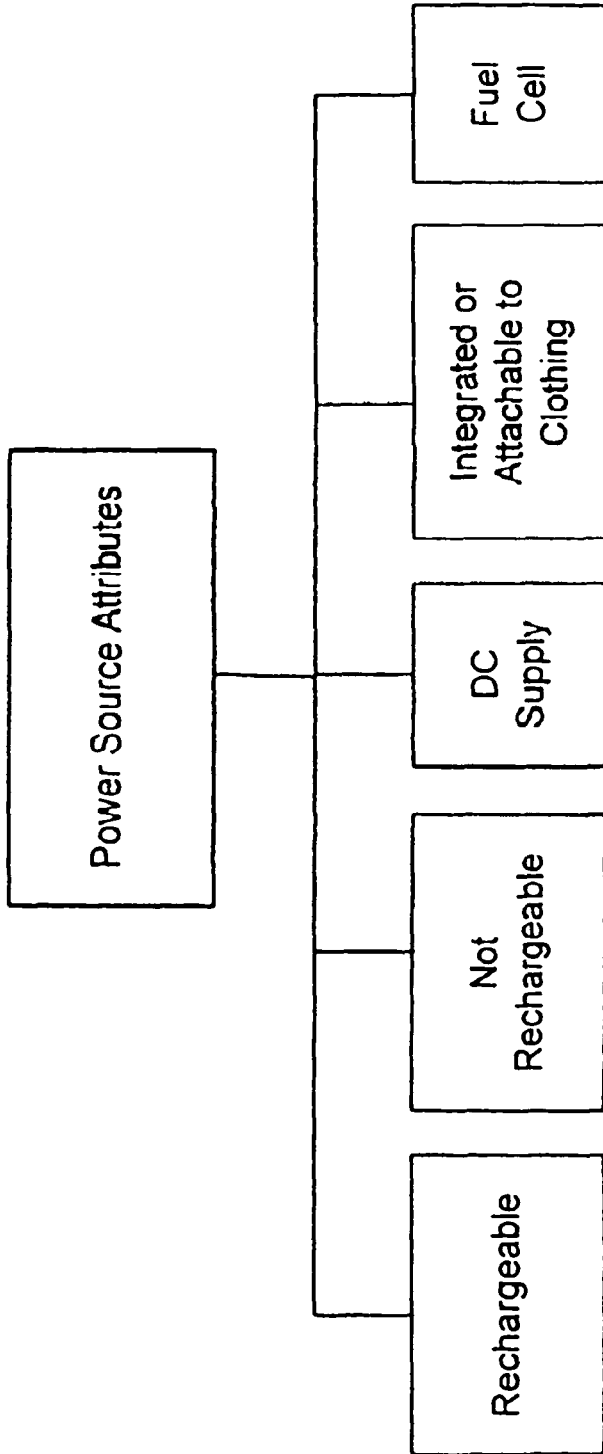

FIG. 10

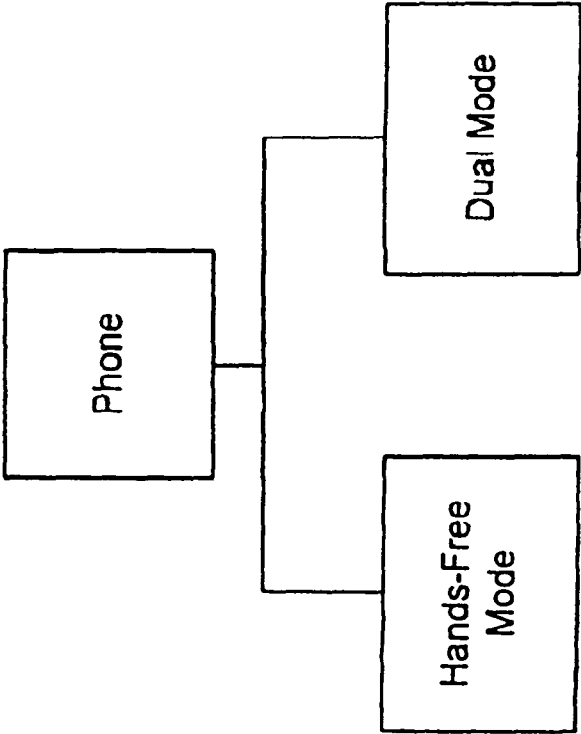

FIG. 11A

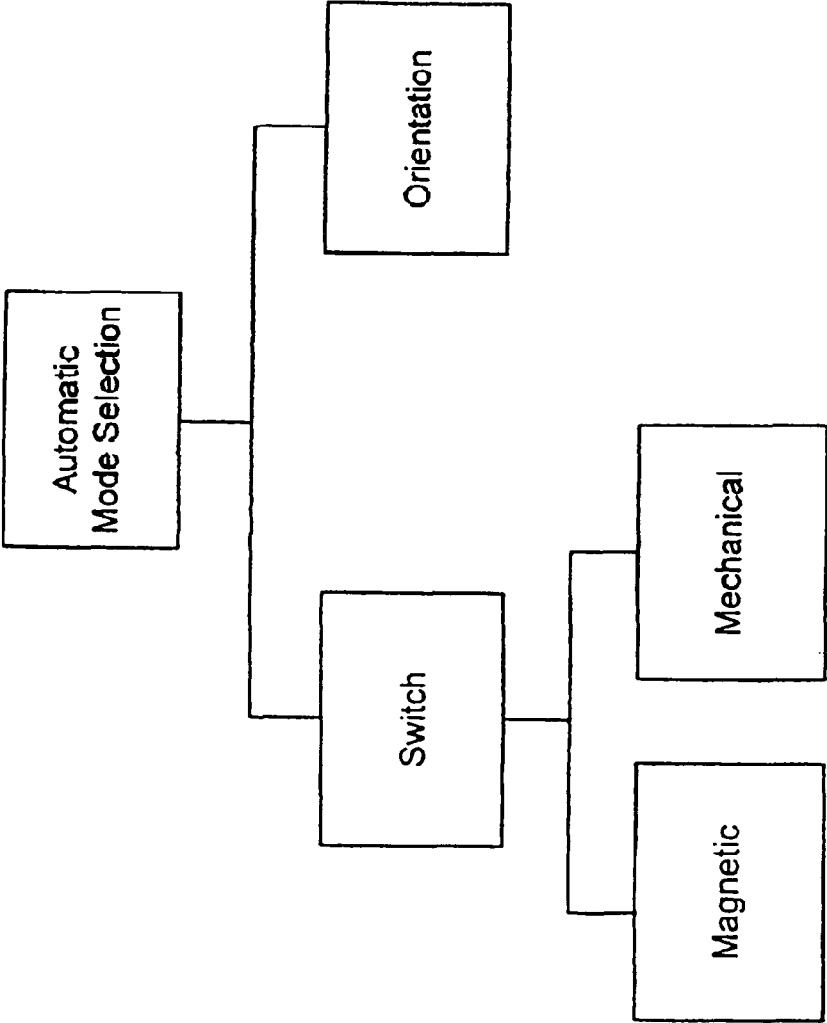

FIG. 11B

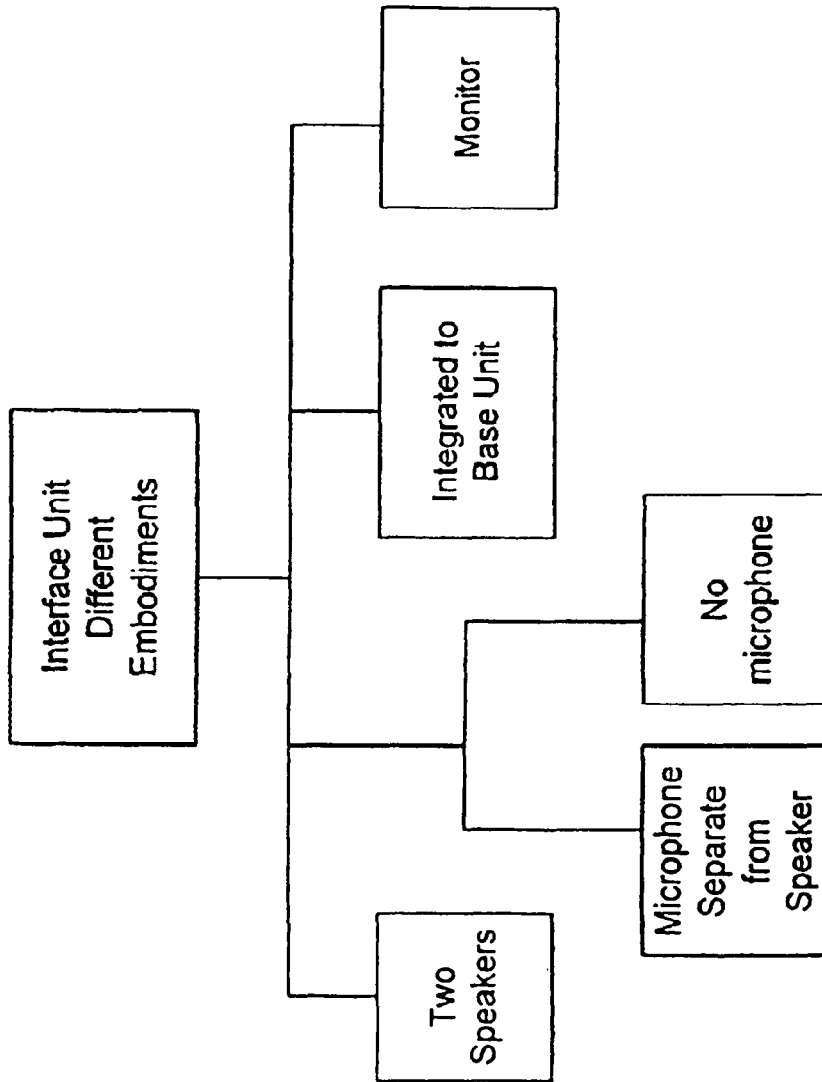

FIG. 12

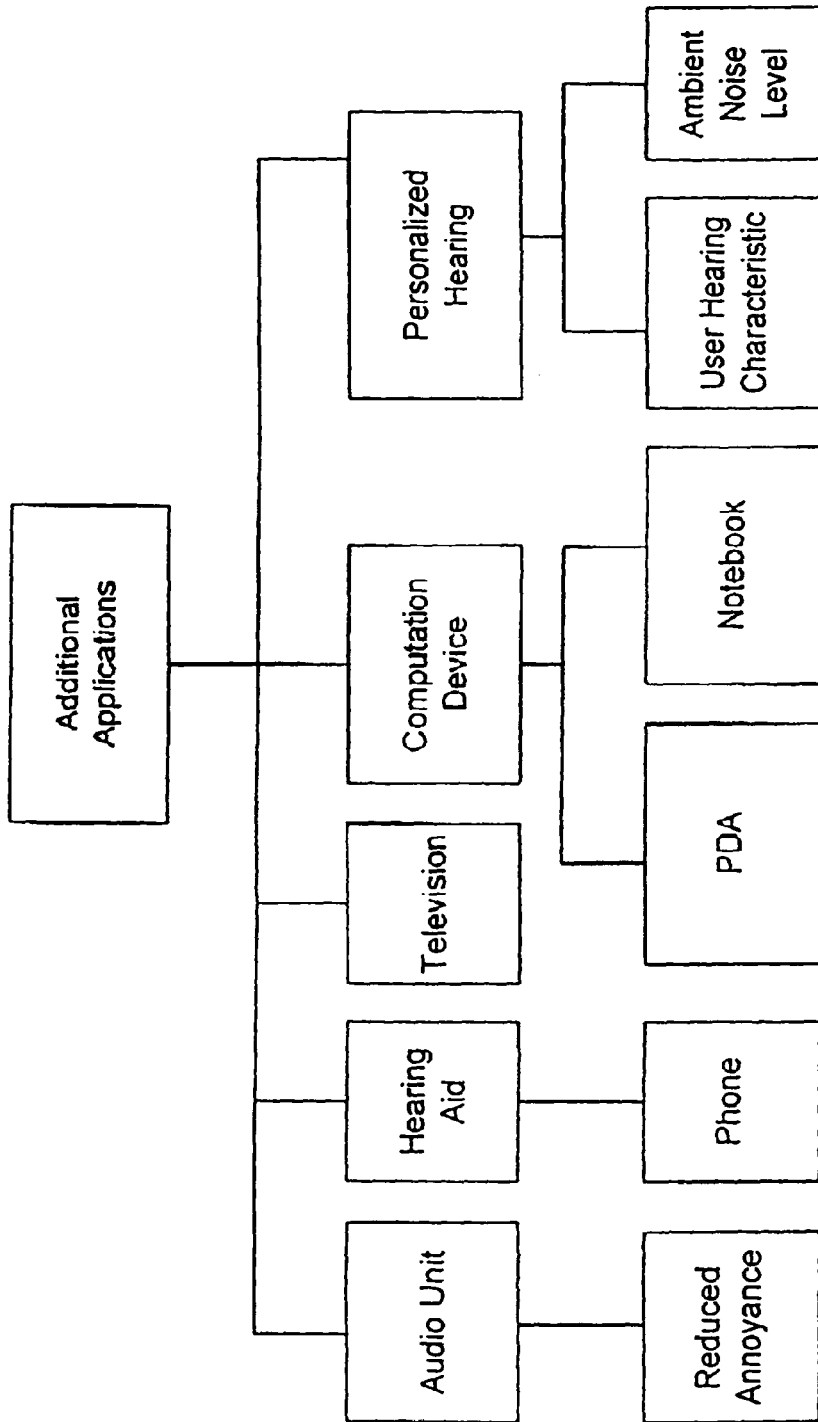

FIG. 13

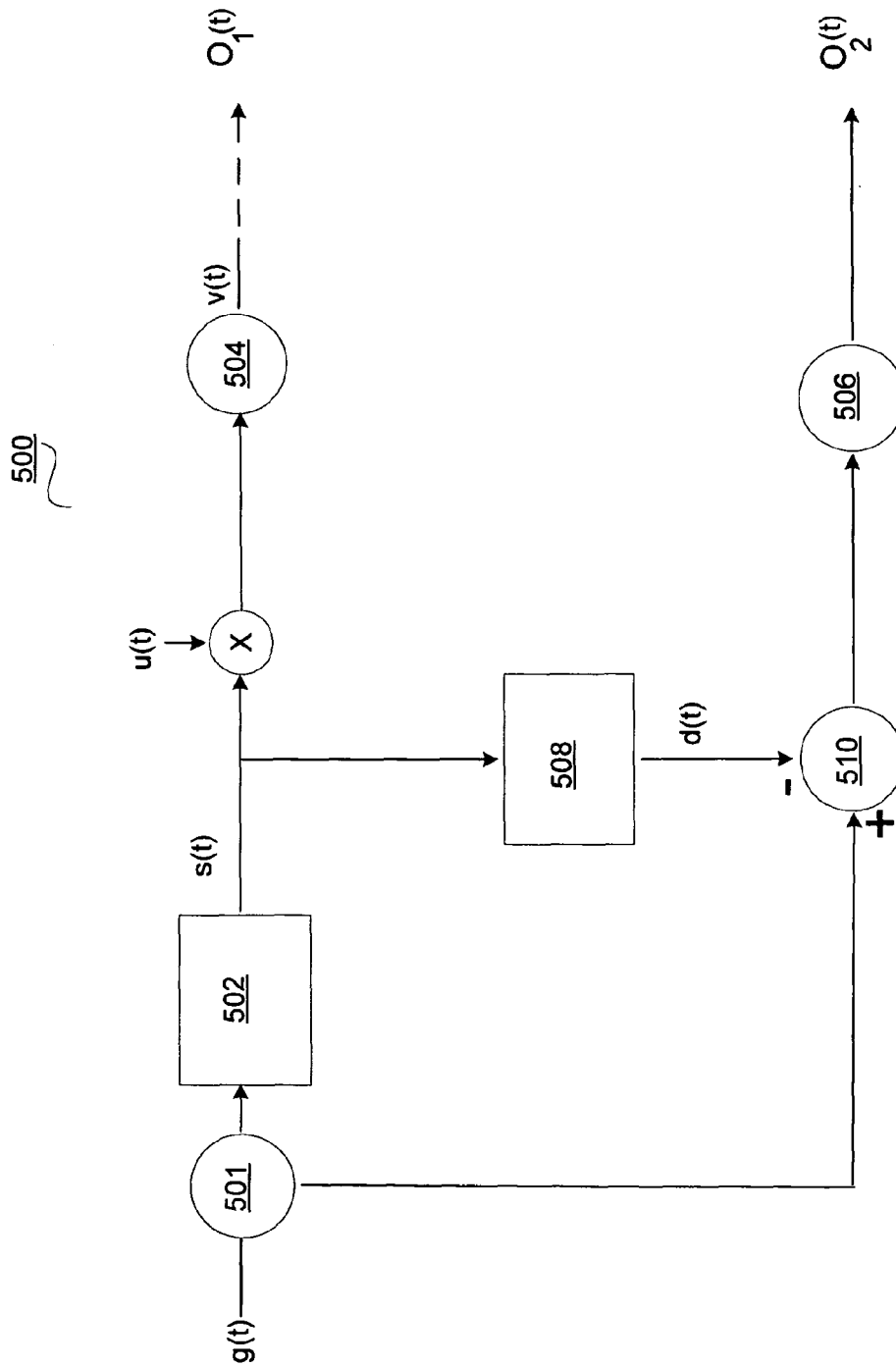

Fig. 14

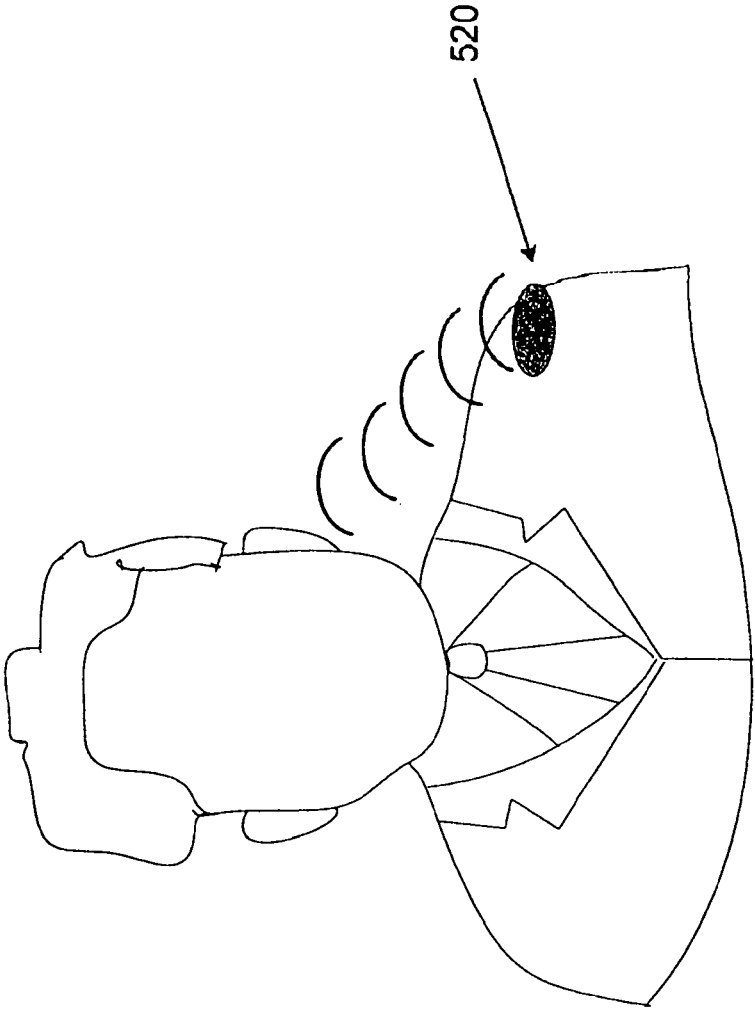

Fig. 15

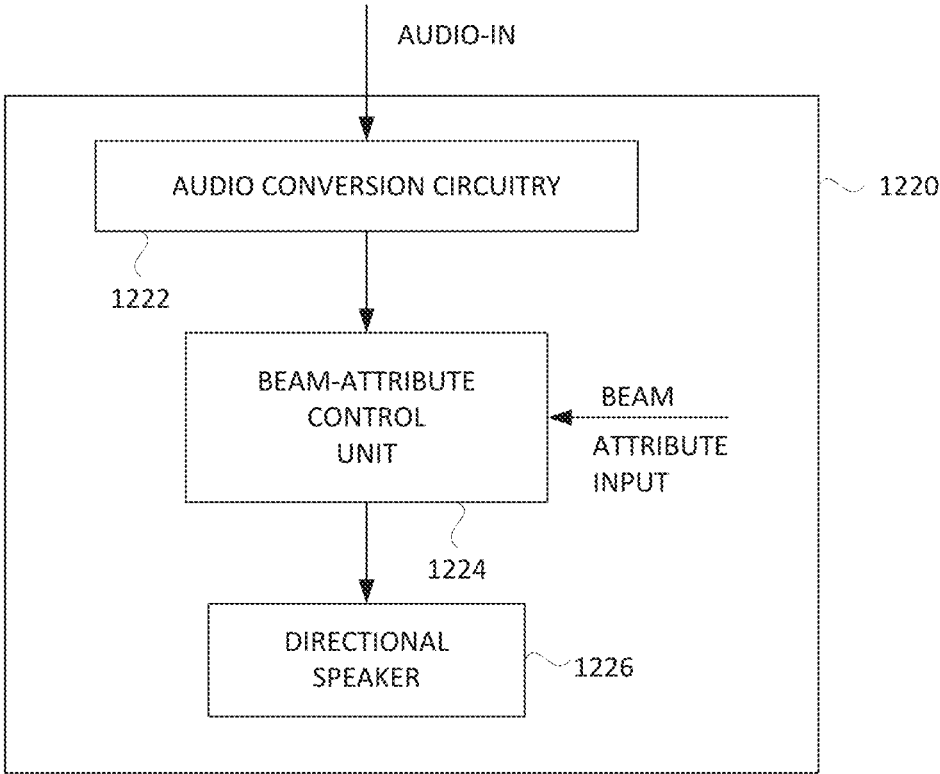

FIG. 16

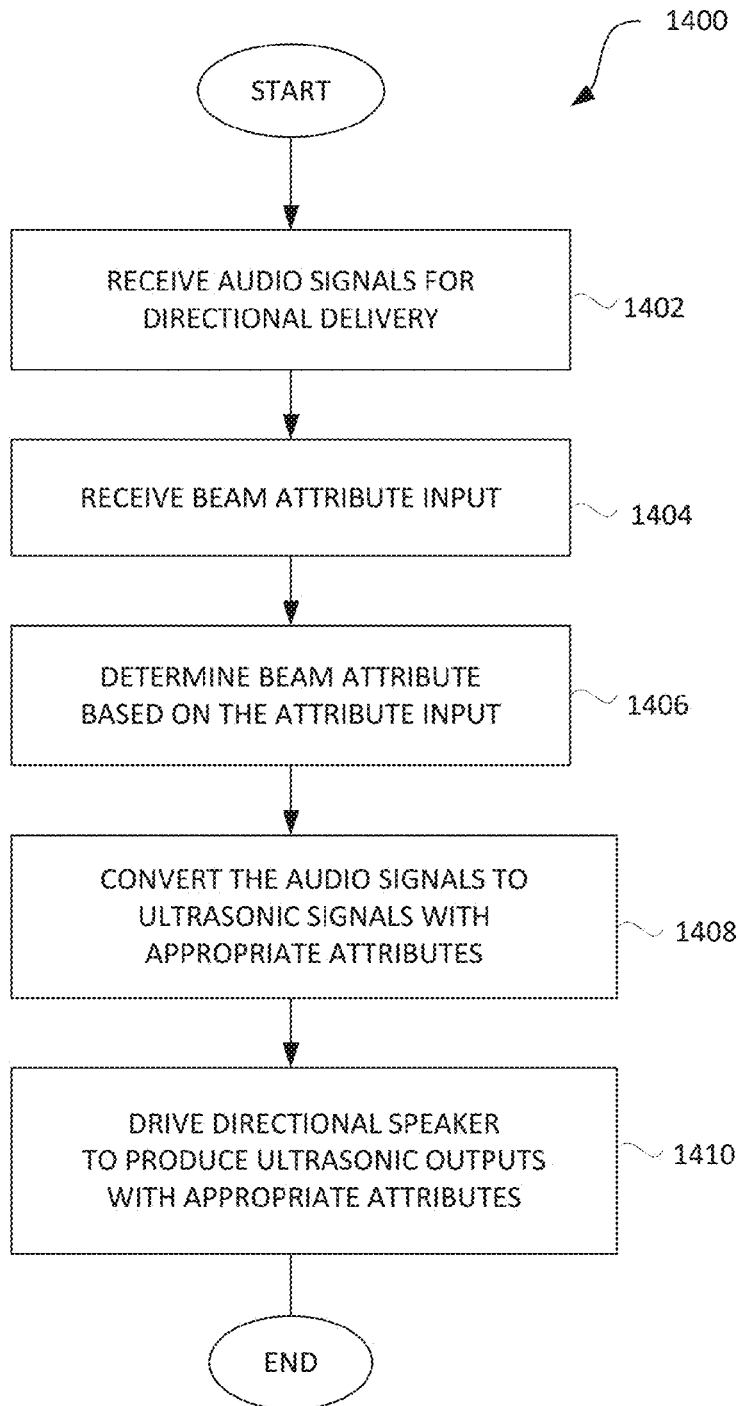

FIG. 17

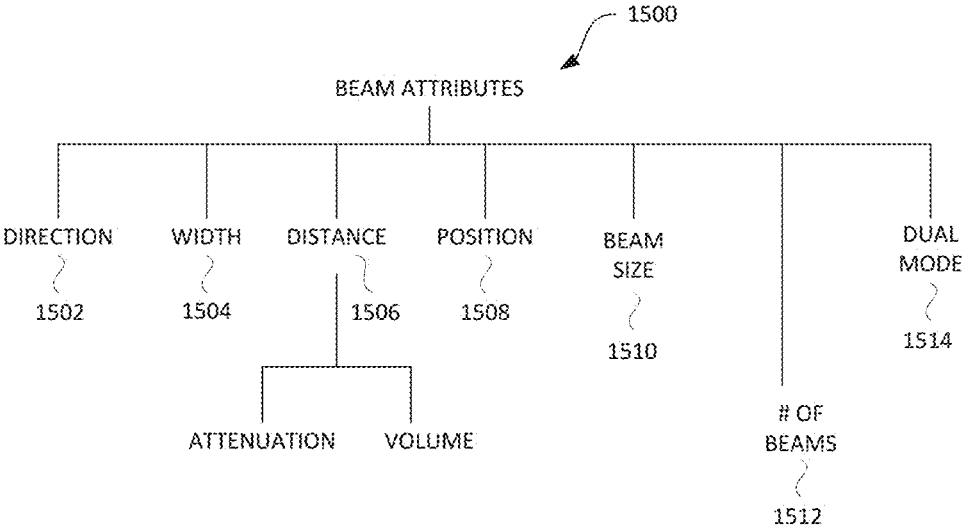

FIG. 18

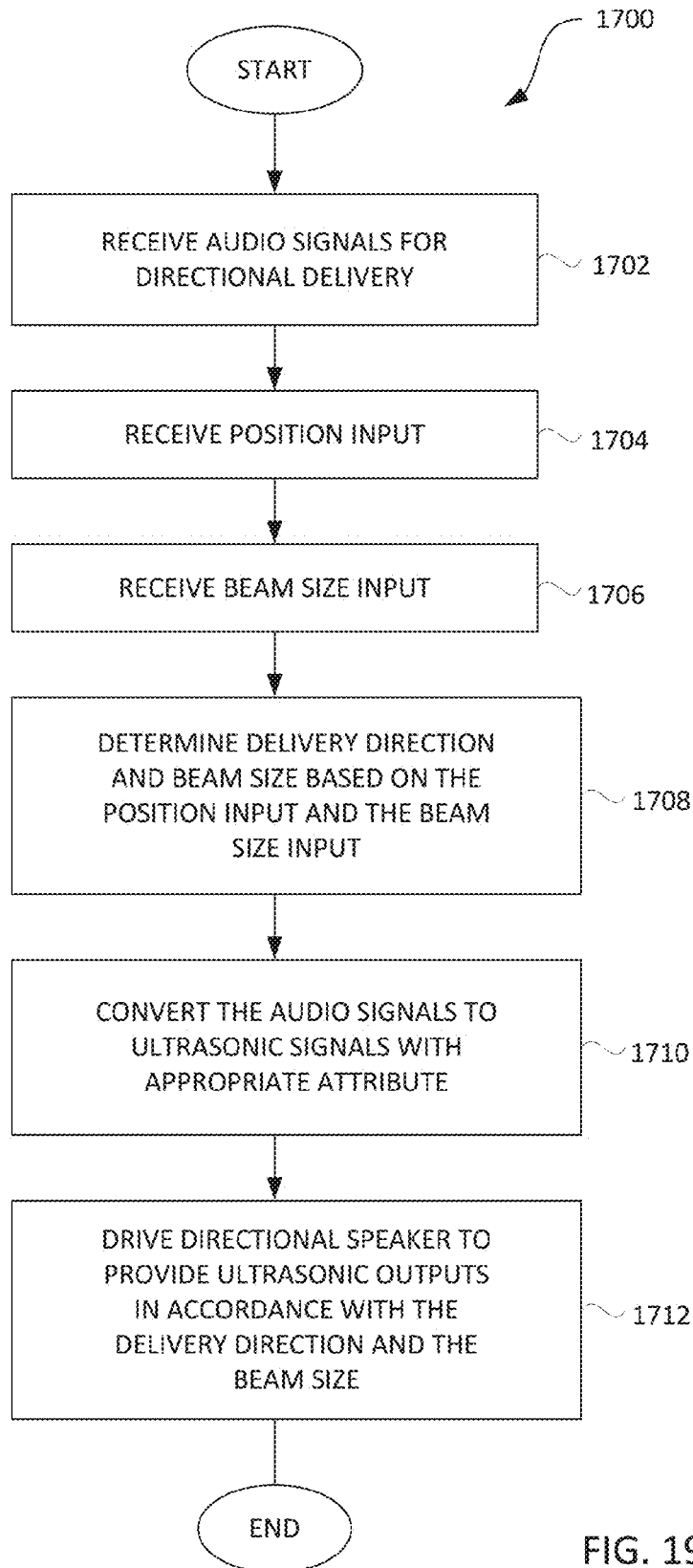

FIG. 19

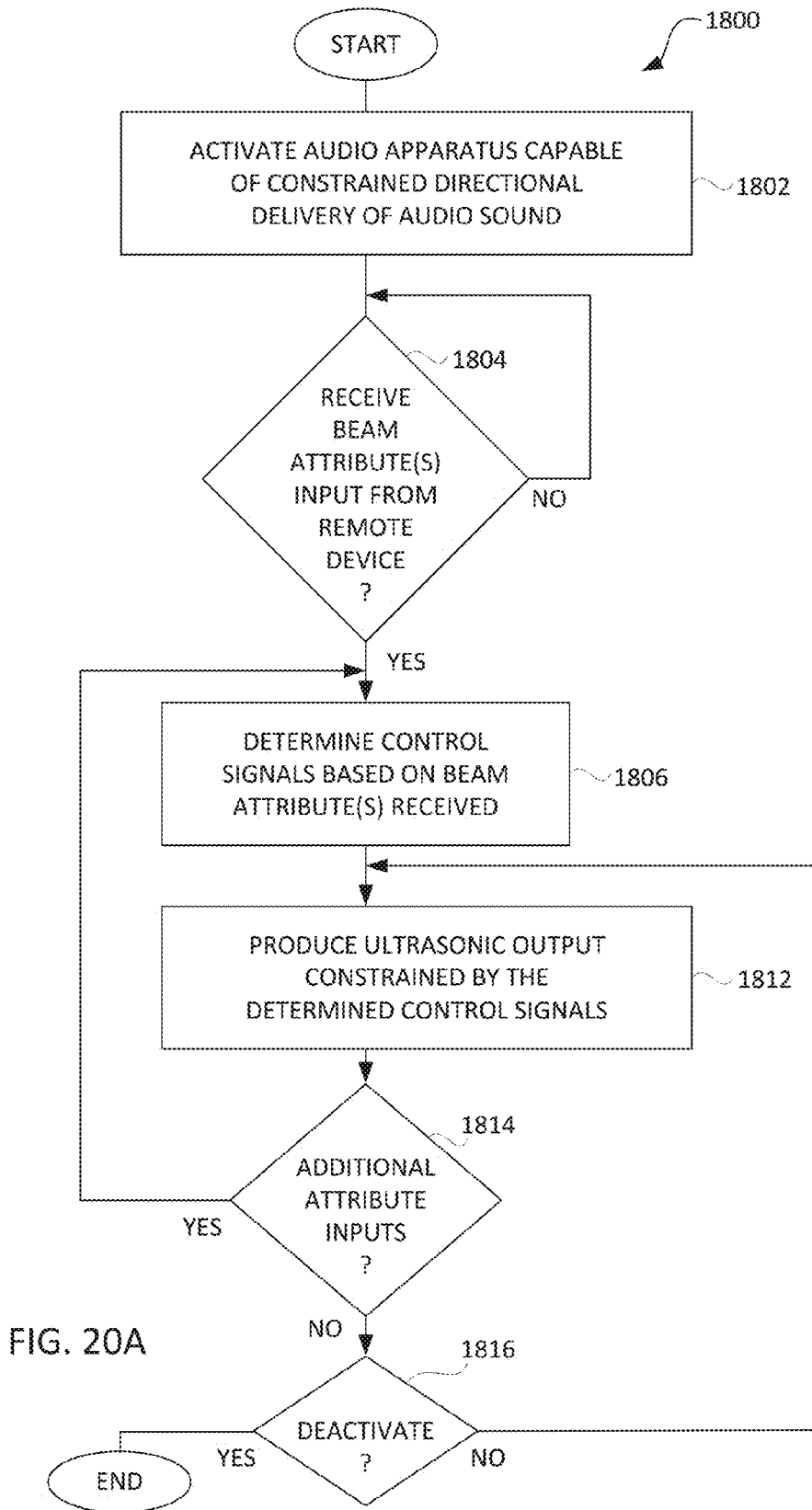
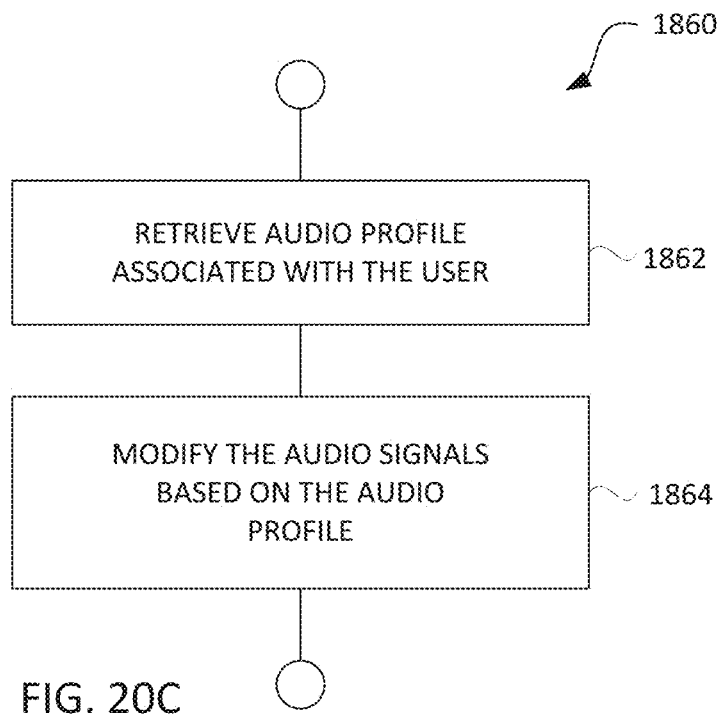
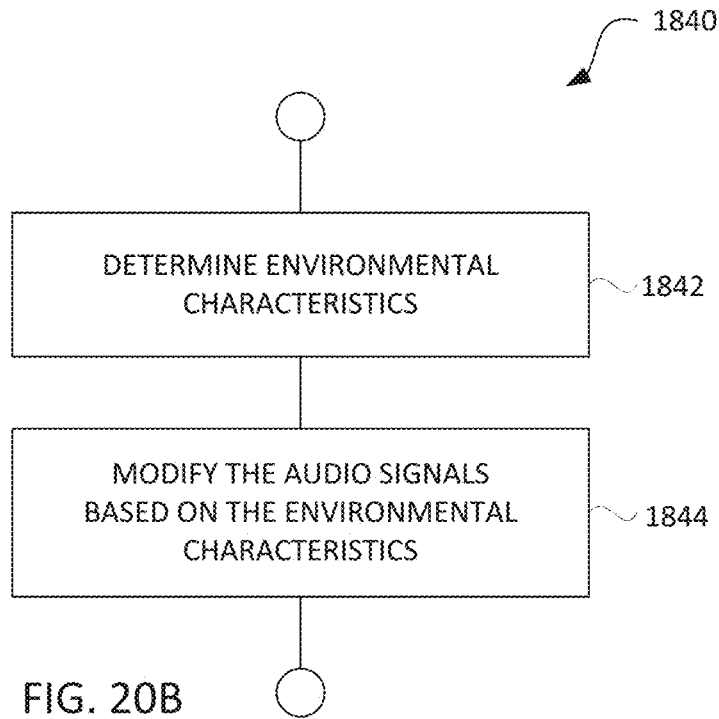

FIG. 20A



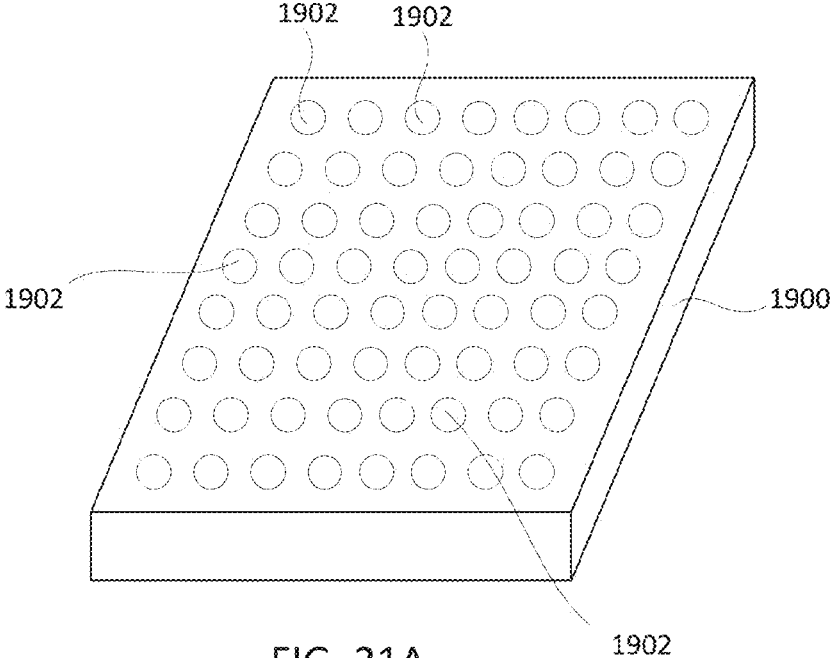

FIG. 21A

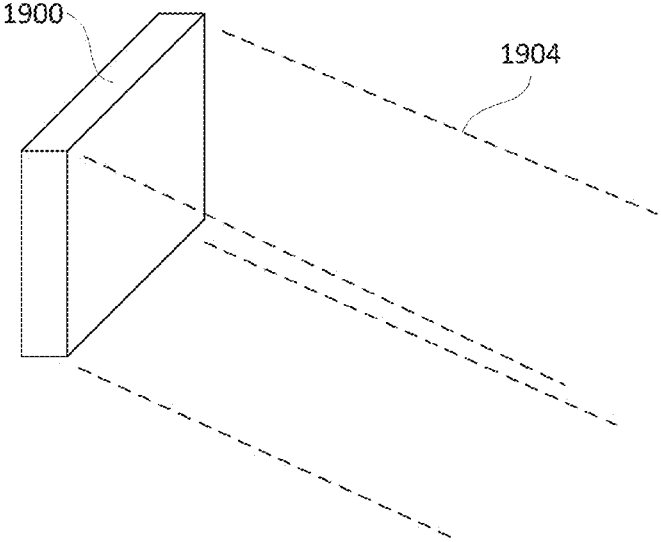

FIG. 21B

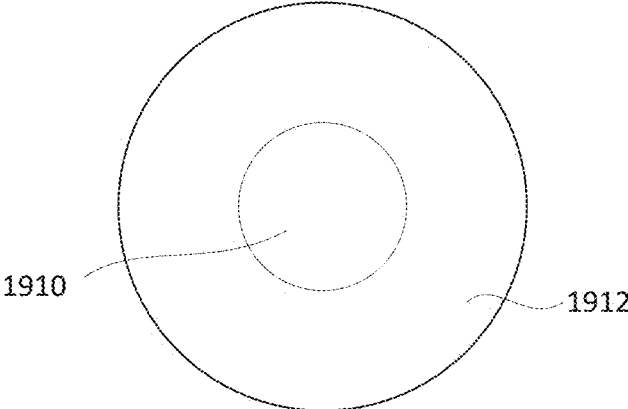

FIG. 21C

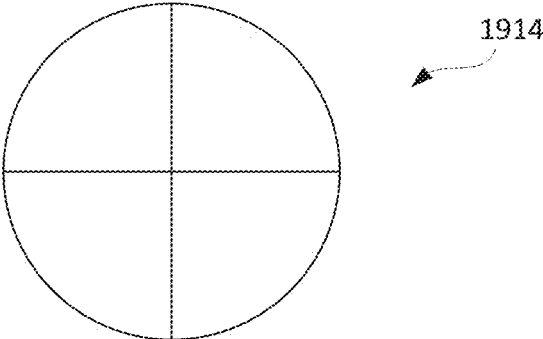

FIG. 21D

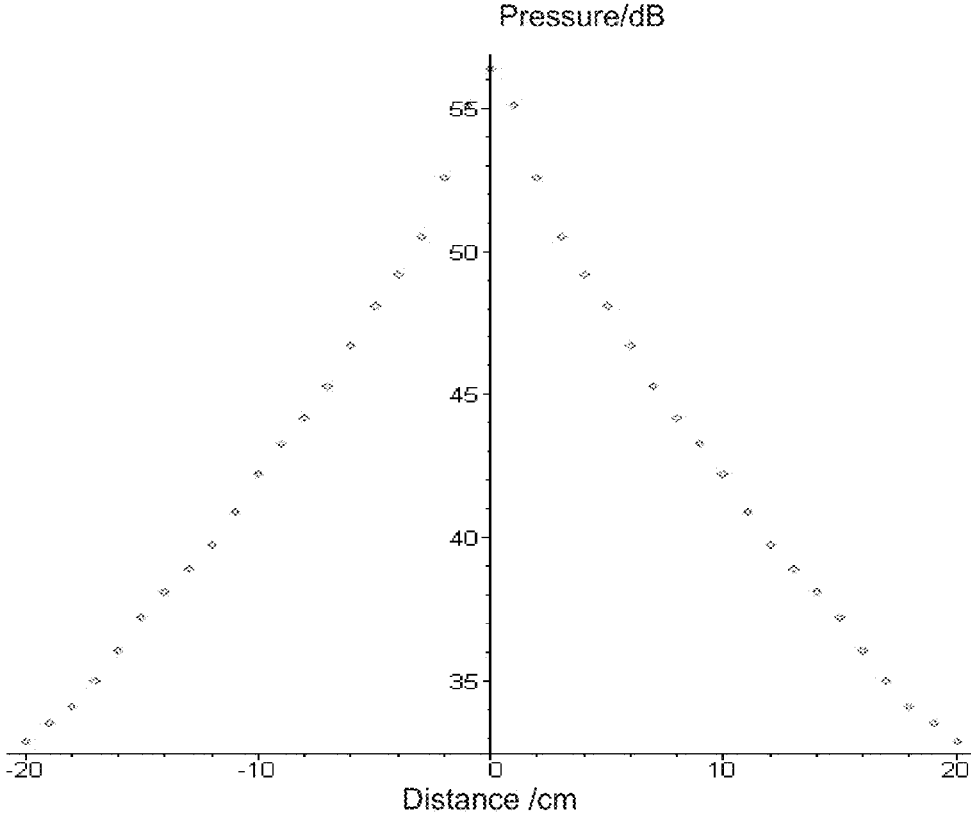

FIG. 21E

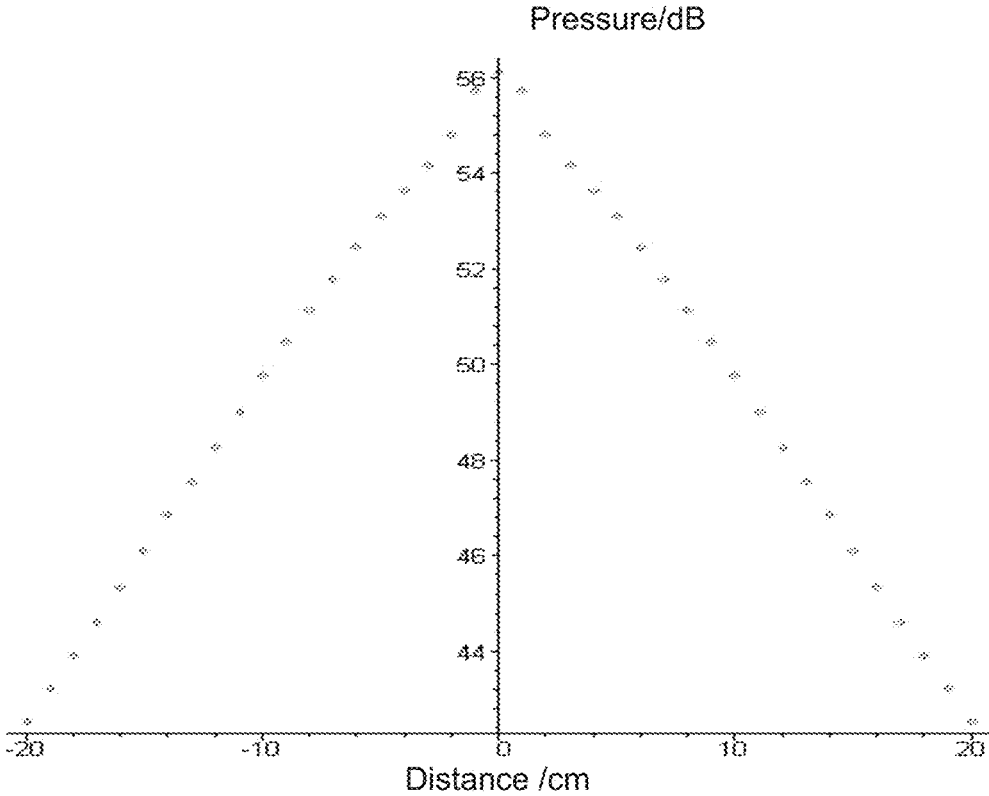

FIG. 21F

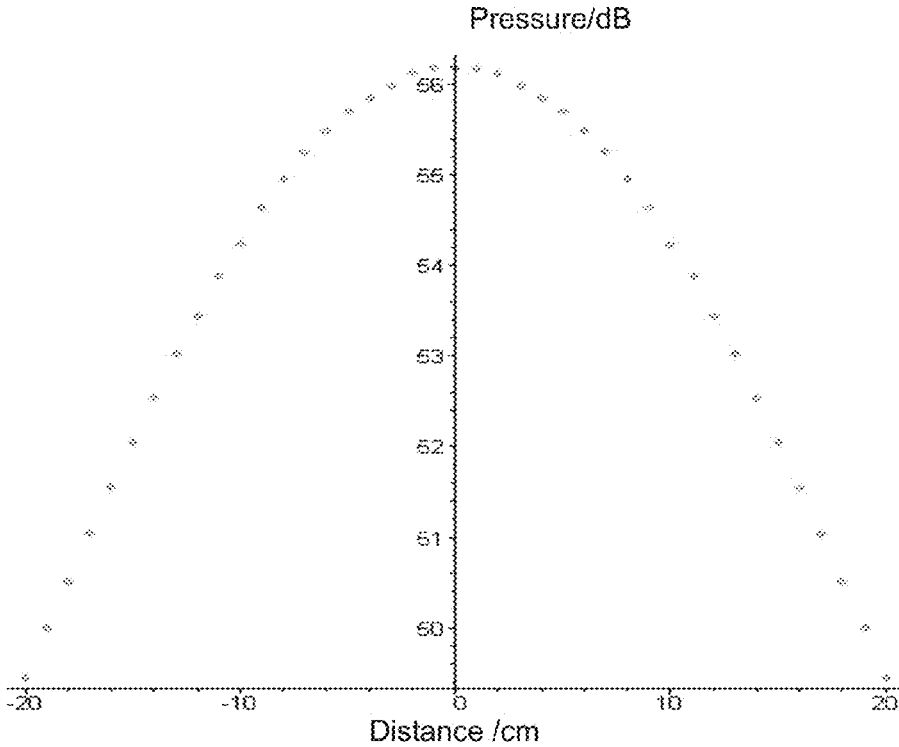
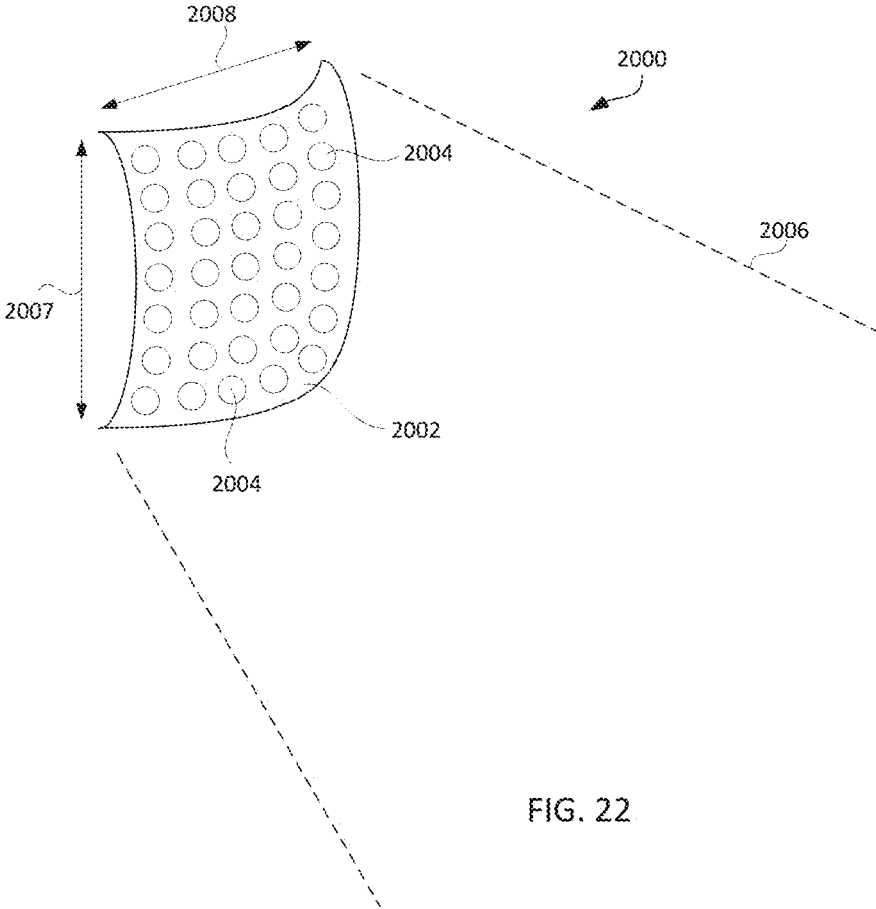

FIG. 21G



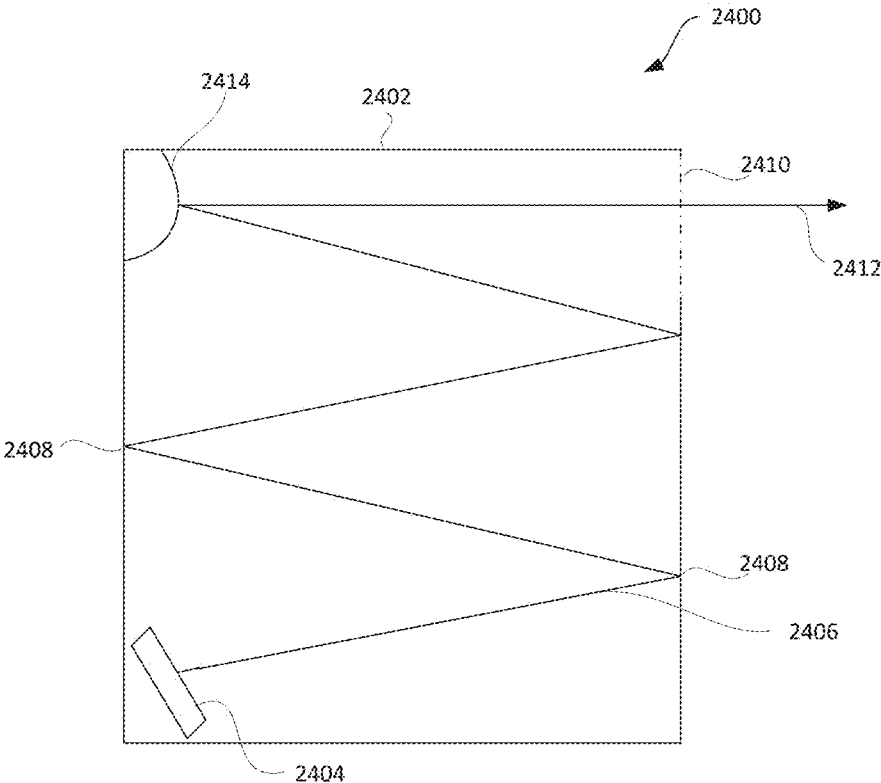

FIG. 23A

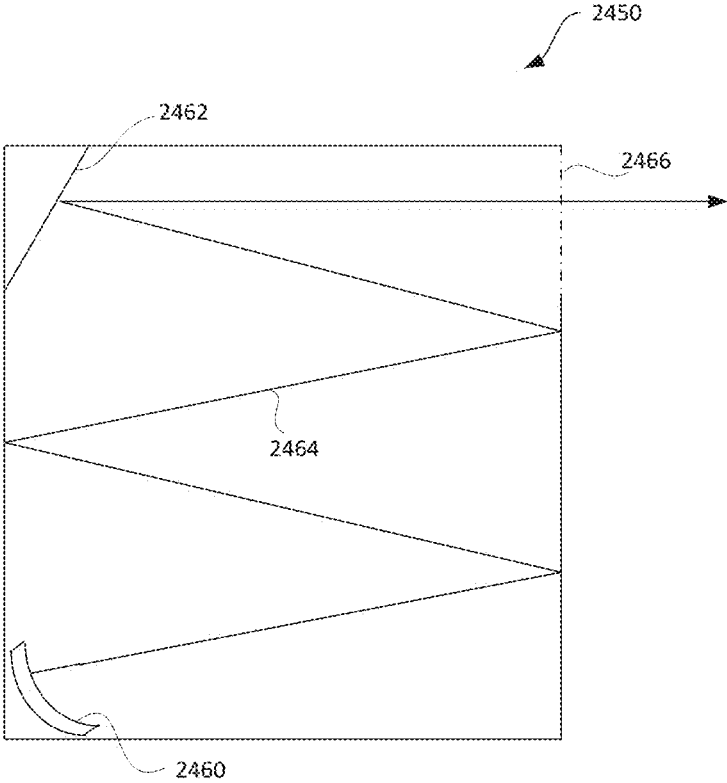

FIG. 23B

HYBRID AUDIO DELIVERY SYSTEM AND METHOD THEREFOR

CROSS-REFERENCE TO RELATED APPLICATIONS

This application is a continuation of U.S. patent application Ser. No. 12/930,344, filed on Jan. 4, 2011, and entitled "HYBRID AUDIO DELIVERY SYSTEM AND METHODS THEREFOR," which is hereby incorporated herein by reference, which application claims priority of U.S. Provisional Patent Application No. 61/335,361, filed Jan. 5, 2010, and entitled "HYBRID AUDIO DELIVERY SYSTEM AND METHOD THEREFOR," which is hereby incorporated herein by reference.

U.S. patent application Ser. No. 12/930,344, filed on Jan. 4, 2011, and entitled "HYBRID AUDIO DELIVERY SYSTEM AND METHOD THEREFOR," is also a continuation in part of U.S. patent application Ser. No. 12/462,601, filed Aug. 6, 2009, now U.S. Pat. No. 8,208,970, and entitled "DIRECTIONAL COMMUNICATION SYSTEMS," which is hereby incorporated herein by reference, which application is a continuation of U.S. patent application Ser. No. 11/893,835, filed Aug. 16, 2007, now U.S. Pat. No. 7,587,227, and entitled "DIRECTIONAL WIRELESS COMMUNICATION SYSTEMS," which is hereby incorporated herein by reference, which application is a continuation of U.S. patent application Ser. No. 10/826,529, filed Apr. 15, 2004, now U.S. Pat. No. 7,269,452, and entitled "DIRECTIONAL WIRELESS COMMUNICATION SYSTEMS," which is hereby incorporated herein by reference, and claims priority of: (i) U.S. Provisional Patent Application No. 60/462,570, filed Apr. 15, 2003, and entitled "WIRELESS COMMUNICATION SYSTEMS OR DEVICES, HEARING ENHANCEMENT SYSTEMS OR DEVICES, AND METHODS THEREFOR," which is hereby incorporated herein by reference; (ii) U.S. Provisional Patent Application No. 60/469,221, filed May 12, 2003, and entitled "WIRELESS COMMUNICATION SYSTEMS OR DEVICES, HEARING ENHANCEMENT SYSTEMS OR DEVICES, DIRECTIONAL SPEAKER FOR ELECTRONIC DEVICE, PERSONALIZED AUDIO SYSTEMS OR DEVICES, AND METHODS THEREFOR," which is hereby incorporated herein by reference; and (iii) U.S. Provisional Patent Application No. 60/493,441, filed Aug. 8, 2003, and entitled "WIRELESS COMMUNICATION SYSTEMS OR DEVICES, HEARING ENHANCEMENT SYSTEMS OR DEVICES, DIRECTIONAL SPEAKER FOR ELECTRONIC DEVICE, AUDIO SYSTEMS OR DEVICES, WIRELESS AUDIO DELIVERY, AND METHODS THEREFOR," which is hereby incorporated herein by reference.

This application is also related to: (i) U.S. patent application Ser. No. 10/826,527, filed Apr. 15, 2004, now U.S. Pat. No. 7,388,962, entitled, "DIRECTIONAL HEARING ENHANCEMENT SYSTEMS," which is hereby incorporated herein by reference; (ii) U.S. patent application Ser. No. 10/826,531, filed Apr. 15, 2004, now U.S. Pat. No. 7,801,570, and entitled, "DIRECTIONAL SPEAKER FOR PORTABLE ELECTRONIC DEVICE," which is hereby incorporated herein by reference; (iii) U.S. patent application Ser. No. 10/826,537 filed Apr. 15, 2004, and entitled, "METHOD AND APPARATUS FOR LOCALIZED DELIVERY OF AUDIO SOUND FOR ENHANCED PRIVACY," which is hereby incorporated herein by reference; and (iv) U.S. patent application Ser. No. 10/826,528, filed Apr. 15, 2004, and entitled, "METHOD AND APPARATUS

FOR WIRELESS AUDIO DELIVERY," which is hereby incorporated herein by reference.

BACKGROUND OF THE INVENTION

Field of the Invention

The present invention relates generally to an audio system, and more particularly, to a directional audio system.

Description of the Related Art

Cell phones and other wireless communication systems have become an integral part of our lives. During the early 20th Century, some predicted that if phone companies continued with their growth rate, everyone would become a phone operator. From a certain perspective, this prediction has actually come true. Cell phones have become so prevalent that many of us practically cannot live without them. As such, we might have become cell phone operators.

However, the proliferation of cell phones has brought on its share of headaches. The number of traffic accidents has increased due to the use of cell phones while driving. The increase is probably due to drivers taking their hands off the steering wheel to engage in phone calls. Instead of holding onto the steering wheel with both hands, one of the driver's hands may be holding a cell phone. Or, even worse, one hand may be holding a phone and the other dialing it. The steering wheel is left either unattended, or, at best, maneuvered by the driver's thighs!

Another disadvantage of cell phones is that they might cause brain tumors. With a cell phone being used so close to one's brain, there are rumors that the chance of getting a brain tumor is increased. One way to reduce the potential risk is to use an earpiece or headset connected to the cell phone.

Earpieces and headsets, however, can be quite inconvenient. Imagine your cell phone rings. You pick up the call but then you have to tell the caller to hold while you unwrap and extend the headset wires, plug the headset to the cell phone, and then put on the headset. This process is inconvenient to both the caller, who has to wait, and to you, as you fumble around to coordinate the use of the headset. Also, many headsets require earpieces. Having something plugged into one's ear is not natural and is annoying to many, especially for long phone calls. Further, if you are jogging or involved in a physical activity, the headset can get dislodged or detached.

It should be apparent from the foregoing that there is still a need for improved ways to enable wireless communication systems to be used hands-free.

SUMMARY

A number of embodiments of the present invention provide a wireless communication system that has a directional speaker. In one embodiment, with the speaker appropriately attached or integral to a user's clothing, the user can receive audio signals from the speaker hands-free. The audio-signals from the speaker are directional, allowing the user to hear the audio signals without requiring an earpiece, while providing certain degree of privacy protection.

The wireless communication system can be a phone. In one embodiment, the system has a base unit coupled to an interface unit. The interface unit includes a directional speaker and a microphone. Audio signals are generated by transforming directional ultrasonic signals (output by the directional speaker) with air. In one embodiment, the inter-

3

face unit can be attached to the shoulder of the user, and the audio signals from the speaker can be directed towards one of the user's ears.

The interface unit can be coupled to the base unit through a wired or wireless connection. The base unit can also be attached to the clothing of the user.

The phone, particularly a cell phone, can be a dual-mode phone. One mode is the hands-free mode phone. The other mode is the normal mode, where the audio signals are generated directly from the speaker.

The interface unit can include two speakers, each located on, or proximate to, a different shoulder of the user. The microphone can also be separate from, and not integrated to, the speaker.

In one embodiment, the speaker can be made of one or more devices that can be piezoelectric thin-film devices, bimorph devices or magnetic transducers. Multiple devices can be arranged to form a blazed grating, with the orthogonal direction of the grating pointed towards the ear. Multiple devices can also be used to form a phase array, which can generate an audio beam that has higher directivity and is steerable.

In another embodiment, the wireless communication system can be used as a hearing aid. The system can also be both a cell phone and a hearing aid, depending on whether there is an incoming call.

In still another embodiment, the interface unit does not have a microphone, and the wireless communication system can be used as an audio unit, such as a CD player. The interface unit can also be applicable for playing video games, watching television or listening to a stereo system. Due to the directional audio signals, the chance of disturbing people in the immediate neighborhood is significantly reduced.

In yet another embodiment, the interface unit is integrated with the base unit. The resulting wireless communication system can be attached to the clothing of the user, with its audio signals directed towards one ear of the user.

In another embodiment, the base unit includes the capability to serve as a computation system, such as a personal digital assistant (PDA) or a portable computer. This allows the user to simultaneously use the computation system (e.g. PDA) as well as making phone calls. The user does not have to use his hand to hold a phone, thus freeing both hands to interact with the computation system. In another approach for this embodiment, the directional speaker is not attached to the clothing of the user, but is integrated to the base unit. The base unit can also be enabled to be connected wirelessly to a local area network, such as to a WiFi or WLAN network, which allows high-speed data as well as voice communication with the network.

In still another embodiment, the wireless communication system is personalized to the hearing characteristics of the user, or is personalized to the ambient noise level in the vicinity of the user.

In one embodiment, a first portion of audio input signals can be pre-processed, with the output used to modulate ultrasonic carrier signals, thereby producing modulated ultrasonic signals. The modulated ultrasonic signals can be transformed into a first portion of audio output signals, which is directional. Based on a second portion of the audio input signals, a standard audio speaker can output a second portion of the audio output signals. Another embodiment further produces distortion compensated signals based on the pre-processed signals. The distortion compensated signals can be subtracted from the second portion of the audio

4

input signals to generate inputs for the standard audio speaker to output the second portion of the audio output signals.

One embodiment includes a speaker arrangement for an audio output apparatus including a filter, a pre-processor, a modulator, an ultrasonic speaker (generating audio signals with the need for non-linear transformation of ultrasonic signals) and a standard speaker (generating audio signals without the need for non-linear transformation of ultrasonic signals). The filter can be configured to separate audio input signals into low frequency signals and high frequency signals. The pre-processor can be operatively connected to receive the high frequency signals from the filter and to perform predetermined preprocessing on the high frequency signals to produce pre-processed signals. The modulator can be operatively connected to the pre-processor to modulate ultrasonic carrier signals by the pre-processed signals thereby producing modulated ultrasonic signals. The ultrasonic speaker can be operatively connected to the modulator to receive the modulated ultrasonic signals and to output ultrasonic output signals which are transformed into high frequency audio output signals. The standard audio speaker can be operatively connected to the filter to receive the low frequency signals and to output low frequency audio output signals. In one embodiment, the speaker arrangement further includes a distortion compensation unit and a combiner. The distortion compensation unit can be operatively connected to the pre-processor to produce distortion compensated signals. The combiner can be operatively connected to the filter to subtract the distortion compensated signals from the low frequency signals to produce inputs for the standard speaker. Another embodiment does not include the filter. Yet another embodiment, noise can be added to the pre-processed signals.

Other aspects and advantages of the present invention will become apparent from the following detailed description, which, when taken in conjunction with the accompanying drawings, illustrates by way of example the principles of the invention.

BRIEF DESCRIPTION OF THE DRAWINGS

FIG. 1 shows one embodiment of the invention with a base unit coupled to a directional speaker and a microphone.

FIG. 2 shows examples of characteristics of a directional speaker of the present invention.

FIG. 3 shows examples of mechanisms to set the direction of audio signals of the present invention.

FIG. 4A shows one embodiment of a blazed grating for the present invention.

FIG. 4B shows an example of a wedge to direct the propagation angle of audio signals for the present invention.

FIG. 5 shows an example of a steerable phase array of devices to generate the directional audio signals in accordance with the present invention.

FIG. 6 shows one example of an interface unit attached to a piece of clothing of a user in accordance with the present invention.

FIG. 7 shows examples of mechanisms to couple the interface unit to a piece of clothing in accordance with the present invention.

FIG. 8 shows examples of different coupling techniques between the interface unit and the base unit in the present invention.

FIG. 9 shows examples of additional attributes of the wireless communication system in the present invention.

5

FIG. 10 shows examples of attributes of a power source for use with the present invention.

FIG. 11A shows the phone being a hands-free or a normal mode phone according to one embodiment of the present invention.

FIG. 11B shows examples of different techniques to automatically select the mode of a dual mode phone in accordance with the present invention.

FIG. 12 shows examples of different embodiments of an interface unit of the present invention.

FIG. 13 shows examples of additional applications for the present invention.

FIG. 14 shows a speaker apparatus including an ultrasonic speaker and a standard speaker according to another embodiment.

FIG. 15 shows a speaker apparatus on a shoulder of a person according to one embodiment.

FIG. 16 is a block diagram of a directional audio delivery device according to an embodiment of the invention.

FIG. 17 is a flow diagram of directional audio delivery processing according to an embodiment of the invention.

FIG. 18 shows examples of attributes of the constrained audio output according to the invention.

FIG. 19 is a flow diagram of directional audio delivery processing according to another embodiment of the invention.

FIG. 20A is a flow diagram of directional audio delivery processing according to yet another embodiment of the invention.

FIG. 20B is a flow diagram of an environmental accommodation process according to one embodiment of the invention.

FIG. 20C is a flow diagram of audio personalization process according to one embodiment of the invention.

FIG. 21A is a perspective diagram of an ultrasonic transducer according to one embodiment of the invention.

FIG. 22B is a diagram that illustrates the ultrasonic transducer with its beam being produced for audio output according to an embodiment of the invention.

FIGS. 22C-22D illustrate two embodiments of the invention where the directional speakers are segmented.

FIGS. 21E-21G show changes in beam width based on different carrier frequencies according to different embodiments of the present invention.

FIG. 22 shows an embodiment of the invention where the directional speaker has a curved surface to expand the beam.

FIGS. 23A-23B show two embodiments of the invention with directional audio delivery devices that allow ultrasonic signals to bounce back and forth before emitting into free space.

Same numerals in FIGS. 1-23 are assigned to similar elements in all the figures. Embodiments of the invention are discussed below with reference to FIGS. 1-23. However, those skilled in the art will readily appreciate that the detailed description given herein with respect to these figures is for explanatory purposes as the invention extends beyond these limited embodiments.

DETAILED DESCRIPTION OF THE INVENTION

One embodiment of the present invention is a wireless communication system that provides improved hands-free usage. The wireless communication system can, for example, be a mobile phone. FIG. 1 shows a block diagram of wireless communication system 10 according to one embodiment of the invention. The wireless communication

6

system 10 has a base unit 12 that is coupled to an interface unit 14. The interface unit 14 includes a directional speaker 16 and a microphone 18. The directional speaker 16 generates directional audio signals.

From basic aperture antenna theory, the angular beam width θ of a source, such as the directional speaker, is roughly λ/D , where θ is the angular full width at half-maximum (FWHM), λ is the wavelength and D is the diameter of the aperture. For simplicity, assume the aperture to be circular.

For ordinary audible signals, the frequency is from a few hundred hertz, such as 500 Hz, to a few thousand hertz, such as 5000 Hz. With the speed of sound in air c being 340 m/s, λ of ordinary audible signals is roughly between 70 cm and 7 cm. For personal or portable applications, the dimension of a speaker can be in the order of a few cm. Given that the acoustic wavelength is much larger than a few cm, such a speaker is almost omni-directional. That is, the sound source is emitting energy almost uniformly at all directions. This can be undesirable if one needs privacy because an omni-directional sound source means that anyone in any direction can pickup the audio signals.

To increase the directivity of the sound source, one approach is to decrease the wavelength of sound, but this can put the sound frequency out of the audible range. Another technique is known as parametric acoustics.

Parametric acoustic operation has previously been discussed, for example, in the following publications: "Parametric Acoustic Array," by P. J. Westervelt, in *J. Acoust. Soc. Am.*, Vol. 35 (4), pp. 535-537, 1963; "Possible exploitation of Non-Linear Acoustics in Underwater Transmitting Applications," by H. O. Berkta, in *J. Sound Vib.* Vol. 2 (4): 435-461 (1965); and "Parametric Array in Air," by Bennett et al., in *J. Acoust. Soc. Am.*, Vol. 57 (3), pp. 562-568, 1975.

In one embodiment, assume that the audible acoustic signal is $f(t)$ where $f(t)$ is a band-limited signal, such as from 500 to 5,000 Hz. A modulated signal $f(t) \sin \omega_c t$ is created to drive an acoustic transducer. The carrier frequency $\omega_c/2\pi$ should be much larger than the highest frequency component of $f(t)$. In an example, the carrier wave is an ultrasonic wave. The acoustic transducer should have a sufficiently wide bandwidth at ω_c to cover the frequency band of the incoming signal $f(t)$. After this signal $f(t) \sin \omega_c t$ is emitted from the transducer, non-linear demodulation occurs in air, creating an audible signal, $E(t)$, where

$$E(t) \propto \partial^2 / \partial t^2 [f^2(\tau)]$$

with $\tau = t - L/c$, and L being the distance between the source and the receiving ear. In this example, the demodulated audio signal is proportional to the second time derivative of the square of the modulating envelope $f(t)$.

To retrieve the audio signal $f(t)$ more accurately, a number of approaches pre-process the original audio signals before feeding them into the transducer. Each has its specific attributes and advantages. One pre-processing approach is disclosed in "Acoustic Self-demodulation of Pre-distorted Carriers," by B. A. Davy, Master's Thesis submitted to U. T. Austin in 1972. The disclosed technique integrates the signal $f(t)$ twice, and then square-roots the result before multiplying it with the carrier $\sin \omega_c t$. The resultant signals are applied to the transducer. In doing so, an infinite harmonics of $f(t)$ could be generated, and a finite transmission bandwidth can create distortion.

Another pre-processing approach is described in "The audio spotlight: An application of nonlinear interaction of sound waves to a new type of loudspeaker design," by Yoneyama et al., *Journal of the Acoustic Society of America*,

Vol. 73 (5), pp. 1532-1536, May 1983. The pre-processing scheme depends on double side-band (DSB) modulation. Let $S(t)=1+m f(t)$, where m is the modulation index. $S(t) \sin \omega_c t$ is used to drive the acoustic transducer instead of $f(t) \sin \omega_c t$. Thus,

$$E(t) \propto \partial^2 / \partial t^2 [S^2(t)] \propto 2m f(t) + m^2 \partial^2 [f(t)^2]$$

The first term provides the original audio signal. But the second term can produce undesirable distortions as a result of the DSB modulation. One way to reduce the distortions is by lowering the modulation index m . However, lowering m may also reduce the overall power efficiency of the system.

In "Development of a parametric loudspeaker for practical use," Proceedings of 10th International Symposium on Non-linear Acoustics, pp. 147-150, 1984, Kamakura et al. introduced a pre-processing approach to remove the undesirable terms. It uses a modified amplitude modulation (MAM) technique by defining $S(t)=[1+m f(t)]^{1/2}$. That is, the demodulated signal $E(t) \propto m f(t)$. The square-rooted envelope operation of the MAM signal can broaden the bandwidth of $S(t)$, and can require an infinite transmission bandwidth for distortion-free demodulation.

In "Suitable Modulation of the Carrier Ultrasound for a Parametric Loudspeaker," *Acoustica*, Vol. 23, pp. 215-217, 1991, Kamakura et al. introduced another pre-processing scheme, known as "envelope modulation". In this scheme, $S(t)=[e(t)+mf(t)]^{1/2}$ where $e(t)$ is the envelope of $f(t)$. The transmitted power was reduced by over 64% using this scheme and the distortion was better than the DSB or single-side band (SSB) modulation, as described in "Self-demodulation of a plane-wave—Study on primary wave modulation for wideband signal transmission," by Aoki et al., *J. Acoust. Soc. Jpn.*, Vol. 40, pp. 346-349, 1984.

Back to directivity, the modulated signals, $S(t) \sin \omega_c t$ or $f(t) \sin \omega_c t$, have a better directivity than the original acoustic signal $f(t)$, because ω_c is higher than the audible frequencies. As an example, ω_c can be $2\pi \cdot 40$ kHz, though experiment has shown that ω_c can range from $2\pi \cdot 20$ kHz to well over $2\pi \cdot 1$ MHz. Typically, ω_c is chosen not to be too high because of the higher acoustic absorption at higher carrier frequencies. Anyway, with ω_c being $2\pi \cdot 40$ kHz, the modulated signals have frequencies that are approximately ten times higher than the audible frequencies. This makes an emitting source with a small aperture, such as 2.5 cm in diameter, a directional device for a wide range of audio signals.

In one embodiment, choosing a proper working carrier frequency ω_c , takes into consideration a number of factors, such as:

1. To reduce the acoustic attenuation, which is generally proportional to ω_c^2 , the carrier frequency ω_c should not be high.
2. The FWHM of the ultrasonic beam should be large enough, such as 25 degrees, to accommodate head motions of the person wearing the portable device and to reduce the ultrasonic intensity through beam expansion.
3. To avoid the near-field effect which may cause amplitude fluctuations, the distance between the emitting device and the receiving ear r should be greater than $0.3 \cdot R_0$, where R_0 is the Rayleigh distance, and is defined as (the area of the emitting aperture/ λ). As an example, with FWHM being 20 degrees,

$$\theta = \lambda/D = (c/2\pi/\omega_c)/D \sim 1/3$$

Assuming D is 2.5 cm, ω_c becomes $2\pi \cdot 40$ kHz. From this relation, it can be seen that the directivity of the ultrasonic beam can be adjusted by changing the carrier frequency ω_c . If a smaller aperture acoustic transducer is preferred, the directivity may decrease. Note also that the power generated by the acoustic transducer is typically proportional to the aperture area. In the above example, the Rayleigh distance R_0 is about 57 mm.

Based on the above description, in one embodiment, directional audio signals can be generated by the speaker **16** even with a relatively small aperture through modulated ultrasonic signals. The modulated signals can be demodulated in air to regenerate the audio signals. The speaker **16** can then generate directional audio signals even when emitted from an aperture that is in the order of a few centimeters. This allows the directional audio signals to be pointed at desired directions.

Note that a number of examples have been described on generating audio signals through demodulating ultrasonic signals. However, the audio signals can also be generated through mixing two ultrasonic signals whose difference frequencies are the audio signals.

FIG. 2 shows examples of characteristics of a directional speaker. The directional speaker can, for example, be the directional speaker **16** illustrated in FIG. 1. The directional speaker can use a piezoelectric thin film. The piezoelectric thin film can be deposited on a plate with many cylindrical tubes. An example of such a device is described in U.S. Pat. No. 6,011,855, which is hereby incorporated by reference. The film can be a polyvinylidene di-fluoride (PVDF) film, and can be biased by metal electrodes. The film can be attached or glued to the perimeter of the plate of tubes. The total emitting surfaces of all of the tubes can have a dimension in the order of a few wavelengths of the carrier or ultrasonic signals. Appropriate voltages applied through the electrodes to the piezoelectric thin film create vibrations of the thin film to generate the modulated ultrasonic signals. These signals cause resonance of the enclosed tubes. After emitted from the film, the ultrasonic signals self-demodulate through non-linear mixing in air to produce the audio signals.

As one example, the piezoelectric film can be about 28 microns in thickness; and the tubes can be $3/4$ " in diameter and spaced apart by 0.16", from center to center of the tube, to create a resonating frequency of around 40 kHz. With the ultrasonic signals being centered around 40 kHz, the emitting surface of the directional speaker can be around 2 cm by 2 cm. A significant percentage of the ultrasonic power generated by the directional speaker can, in effect, be confined in a cone.

To calculate the amount of power within the cone, for example, as a rough estimation, assume that (a) the emitting surface is a uniform circular aperture with the diameter of 2.8 cm, (b) the wavelength of the ultrasonic signals is 8.7 mm, and (c) all power goes to the forward hemisphere, then the ultrasonic power contained within the FWHM of the main lobe is about 97%, and the power contained from null to null of the main lobe is about 97.36%. Similarly, again as a rough estimation, if the diameter of the aperture drops to 1 cm, the power contained within the FWHM of the main lobe is about 97.2%, and the power contained from null to null of the main lobe is about 99%.

Referring back to the example of the piezoelectric film, the FWHM of the signal beam is about 24 degrees. Assume that such a directional speaker **16** is placed on the shoulder of a user. The output from the speaker can be directed in the direction of one of the ears of the user, with the distance

between the shoulder and the ear being, for example, 8 inches. More than 75% of the power of the audio signals generated by the emitting surface of the directional speaker can, in effect, be confined in a cone. The tip of the cone is at the speaker, and the mouth of the cone is at the location of the user's ear. The diameter of the mouth of the cone, or the diameter of the cone in the vicinity of the ear, is less than about 4 inches.

In another embodiment, the directional speaker can be made of a bimorph piezoelectric transducer. The transducer can have a cone of about 1 cm in diameter. In yet another embodiment, the directional speaker can be a magnetic transducer. In a further embodiment, the directional speaker does not generate ultrasonic signals, but generates audio signals directly; and the speaker includes, for example, a physical horn or cone to direct the audio signals.

In yet another embodiment, the power output from the directional speaker is increased by increasing the transformation efficiency (e.g., demodulation or mixing efficiency) of the ultrasonic signals. According to the Berktaý's formula, as disclosed, for example, in "Possible exploitation of Non-Linear Acoustics in Underwater Transmitting Applications," by H. O. Berktaý, in *J. Sound Vib.* Vol. 2 (4):435-461 (1965), which is hereby incorporated by reference, output audio power is proportional to the coefficient of non-linearity of the mixing or demodulation medium. One approach to increase the efficiency is to have at least a portion of the transformation performed in a medium other than air.

As explained, in one embodiment, based on parametric acoustic techniques, directional audio signals can be generated. FIG. 3 shows examples of mechanisms to direct the ultrasonic signals. They represent different approaches, which can utilize, for example, a grating, a malleable wire, or a wedge.

FIG. 4A shows one embodiment of a directional speaker 50 having a blazed grating. The speaker 50 is, for example, suitable for use as the directional speaker 16. Each emitting device, such as 52 and 54, of the speaker 50 can be a piezoelectric device or another type of speaker device located on a step of the grating. In one embodiment, the sum of all of the emitting surfaces of the emitting devices can have a dimension in the order of a few wavelengths of the ultrasonic signals.

In another embodiment, each of the emitting devices can be driven by a replica of the ultrasonic signals with an appropriate delay to cause constructive interference of the emitted waves at the blazing normal 56, which is the direction orthogonal to grating. This is similar to the beam steering operation of a phase array, and can be implemented by a delay matrix. The delay between adjacent emitting surfaces can be approximately h/c , with the height of each step being h . One approach to simplify signal processing is to arrange the height of each grating step to be an integral multiple of the ultrasonic or carrier wavelength, and all the emitting devices can be driven by the same ultrasonic signals.

Based on the grating structure, the array direction of the virtual audio sources can be the blazing normal 56. In other words, the structure of the steps can set the propagation direction of the audio signals. In the example shown in FIG. 4A, there are three emitting devices or speaker devices, one on each step. The total emitting surfaces are the sum of the emitting surfaces of the three devices. The propagation direction is approximately 45 degrees from the horizontal plane. The thickness of each speaker device can be less than

half the wavelength of the ultrasonic waves. If the frequency of the ultrasonic waves is 40 kHz, the thickness can be about 4 mm.

Another approach to direct the audio signals to specific directions is to position a directional speaker of the present invention at the end of a malleable wire. The user can bend the wire to adjust the direction of propagation of the audio signals. For example, if the speaker is placed on the shoulder of a user, the user can bend the wire such that the ultrasonic signals produced by the speaker are directed towards the ear adjacent to the shoulder of the user.

Still another approach is to position the speaker device on a wedge. FIG. 4B shows an example of a wedge 75 with a speaker device 77. The angle of the wedge from the horizontal can be about 40 degrees. This sets the propagation direction 79 of the audio signals to be about 50 degrees from the horizon.

In one embodiment, the ultrasonic signals are generated by a steerable phase array of individual devices, as illustrated, for example, in FIG. 5. They generate the directional signals by constructive interference of the devices. The signal beam is steerable by changing the relative phases among the array of devices.

One way to change the phases in one direction is to use a one-dimensional array of shift registers. Each register shifts or delays the ultrasonic signals by the same amount. This array can steer the beam by changing the clock frequency of the shift registers. These can be known as "x" shift registers. To steer the beam independently also in an orthogonal direction, one approach is to have a second set of shift registers controlled by a second variable rate clock. This second set of registers, known as "y" shift registers, is separated into a number of subsets of registers. Each subset can be an array of shift registers and each array is connected to one "x" shift register. The beam can be steered in the orthogonal direction by changing the frequency of the second variable rate clock.

For example, as shown in FIG. 5, the acoustic phase array is a 4 by 4 array of speaker devices. The devices in the acoustic phase array are the same. For example, each can be a bimorph device or transmitter of 7 mm in diameter. The overall size of the array can be around 2.8 cm by 2.8 cm. The carrier frequency can be set to 100 kHz. Each bimorph is driven at less than 0.1 W. The array is planar but each bimorph is pointed at the ear, such as at about 45 degrees to the array normal. The FWHM main lobe of each individual bimorph is about 0.5 radian.

There can be 4 "x" shift registers. Each "x" shift register can be connected to an array of 4 "y" shift registers to create a 4 by 4 array of shift registers. The clocks can be running at approximately 10 MHz (100 ns per shift). The ultrasonic signals can be transmitted in digital format and delayed by the shift registers at the specified amount.

Assuming the distance of the array from an ear is approximately 20 cm, the main lobe of each array device covers an area of roughly 10 cm \times 10 cm around the ear. As the head can move over an area of 10 cm \times 10 cm, the beam can be steerable roughly by a phase of 0.5 radian over each direction. This is equivalent to a maximum relative time delay of 40 μ s across one direction of the phase array, or 5 μ s of delay per device.

For a n by n array, the ultrasonic beam from each array element interferes with each other to produce a final beam that is $1/n$ narrower in beam width. In the above example, n is equal to 4, and the beam shape of the phase array is narrowed by a factor of 4 in each direction. That is, the

FWHM is less than 8 degrees, covering an area of roughly 2.8 cm×2.8 cm around the ear.

With power focused into a smaller area, the power requirement is reduced by a factor of $1/n^2$, significantly improving power efficiency. In one embodiment, the above array can give the acoustic power of over 90 dB SPL.

Instead of using the bimorph devices, the above example can use an array of piezoelectric thin film devices.

In one embodiment, the interface unit can also include a pattern recognition device that identifies and locates the ear, or the ear canal. Then, if the ear or the canal can be identified, the beam is steered more accurately to the opening of the ear canal. Based on closed loop control, the propagation direction of the ultrasonic signals can be steered by the results of the pattern recognition approach.

One pattern recognition approach is based on thermal mapping to identify the entrance to the ear canal. Thermal mapping can be through infrared sensors. Another pattern recognition approach is based on a pulsed-infrared LED, and a reticon or CCD array for detection. The reticon or CCD array can have a broadband interference filter on top to filter light, which can be a piece of glass with coating.

Note that if the system cannot identify the location of the ear or the ear canal, the system can expand the cone, or decrease its directivity. For example, all array elements can emit the same ultrasonic signals, without delay, but with the frequency decreased.

Privacy is often a concern for users of cell phones. Unlike music or video players where users passively receive information or entertainment, with cell phones, there is a two-way communication. In most circumstances, cell phone users have gotten accustomed to people hearing what they have to say. At least, they can control or adjust their part of the communication. However, cell phone users typically do not want others to be aware of their entire dialogue. Hence, for many applications, at least the voice output portion of the cell phone should provide some level of privacy. With the directional speaker as discussed herein, the audio signals are directional, and thus the wireless communication system provides certain degree of privacy protection.

FIG. 6 shows one example of the interface unit **100** attached to a jacket **102** of the user. The interface unit **100** includes a directional speaker **104** and a microphone **106**. The directional speaker **104** emits ultrasonic signals in the general direction towards an ear of the user. The ultrasonic signals are transformed by mixing or demodulating in the air between the speaker and ear. The directional ultrasonic signals confine most of the audio energy within a cone **108** that is pointed towards the ear of the user. The surface area of the cone **108** when it reaches the head of the user can be tailored to be smaller than the head of the user. Hence, the directional ultrasonic signals are able to provide certain degree of privacy protection.

In one embodiment, there is one or more additional speaker devices provided within, proximate to, or around the directional speaker. The user's head can scatter a portion of the received audio signals. Others in the vicinity of the user may be able to pick up these scattered signals. The additional speaker devices, which can be piezoelectric devices, transmit random signals to interfere or corrupt the scattered signals or other signals that may be emitted outside the cone **108** of the directional signals to reduce the chance of others comprehending the scattered signals.

FIG. 7 shows examples of mechanisms to couple an interface unit to a piece of clothing. For example, the interface unit can be integrated into a user's clothing, such as located between the outer surface of the clothing and its

inner lining. To receive power or other information from the outside, the interface unit can have an electrical protrusion from the inside of the clothing.

Instead of integrated into the clothing, in another embodiment, the interface unit can be attachable to the user's clothing. For example, a user can attach the interface unit to his clothing, and then turn it on. Once attached, the unit can be operated hands-free. The interface unit can be attached to a strap on the clothing, such as the shoulder strap of a jacket. The attachment can be through a clip, a pin or a hook. There can be a small pocket, such as at the collar bone area or the shoulder of the clothing, with a mechanism (e.g., a button) to close the opening of the pocket. The interface unit can be located in the pocket. In another example, a fastener can be on both the interface unit and the clothing for attachment purposes. In one example, the fastener can use hooks and loops (e.g., VELCRO brand fasteners). The interface unit can also be attached by a band, which can be elastic (e.g., an elastic armband). Or, the interface unit can be hanging from the neck of the user with a piece of string, like an ornamental design on a necklace. In yet another example, the interface unit can have a magnet, which can be magnetically attached to a magnet on the clothing. Note that one or more of these mechanisms can be combined to further secure the attachment. In yet another example, the interface unit can be disposable. For example, the interface unit could be disposed of once it runs out of power.

Regarding the coupling between the interface unit and the base unit, FIG. 8 shows examples of a number of coupling techniques. The interface unit may be coupled wirelessly or tethered to the base unit through a wire. In the wireless embodiment, the interface unit may be coupled through Bluetooth, WiFi, Ultrawideband (UWB) or other wireless network/protocol.

FIG. 9 shows examples of additional attributes of the wireless communication system of the present invention. The system can include additional signal processing techniques. Typically, single-side band (SSB) or lower-side band (LSB) modulation can be used with or without compensation for fidelity reproduction. If compensation is used, a processor (e.g., digital signal processor) can be deployed based on known techniques. Other components/functions can also be integrated with the processor. This can be local oscillation for down or up converting and impedance matching circuitry. Echo cancellation techniques may also be included in the circuitry. However, since the speaker is directional, the echo cancellation circuitry may not be necessary. These other functions can also be performed by software (e.g., firmware or microcode) executed by the processor.

The base unit can have one or more antennae to communicate with base stations or other wireless devices. Additional antennae can improve antenna efficiency. In the case where the interface unit wirelessly couples to the base unit, the antenna on the base unit can also be used to communicate with the interface unit. In this situation, the interface unit may also have more than one antenna.

The antenna can be integrated to the clothing. For example, the antenna and the base unit can both be integrated to the clothing. The antenna can be located at the back of the clothing.

The system can have a maximum power controller that controls the maximum amount of power delivered from the interface unit. For example, average output audio power can be set to be around 60 dB, and the maximum power controller limits the maximum output power to be below 70

dB. In one embodiment, this maximum power is in the interface unit and is adjustable.

The wireless communication system may be voice activated. For example, a user can enter, for example, phone numbers using voice commands. Information, such as phone numbers, can also be entered into a separate computer and then downloaded to the communication system. The user can then use voice commands to make connections to other phones.

The wireless communication system can have an in-use indicator. For example, if the system is in operation as a cell phone, a light source (e.g., a light-emitting diode) at the interface unit can operate as an in-use indicator. In one implementation, the light source can flash or blink to indicate that the system is in-use. The in-use indicator allows others to be aware that the user is, for example, on the phone.

In yet another embodiment, the base unit of the wireless communication system can also be integrated to the piece of clothing. The base unit can have a data port to exchange information and a power plug to receive power. Such port or ports can protrude from the clothing.

FIG. 10 shows examples of attributes of the power source. The power source may be a rechargeable battery or a non-rechargeable battery. As an example, a bimorph piezoelectric device, such as AT/R40-12P from Nicera, Nippon Ceramic Co., Ltd., can be used as a speaker device to form the speaker. It has a resistance of 1,000 ohms. Its power dissipation can be in the milliwatt range. A coin-type battery that can store a few hundred mAHours of energy has sufficient power to run the unit for a limited duration of time. Other types of batteries are also applicable.

The power source can be from a DC supply. The power source can be attachable, or integrated or embedded in a piece of clothing worn by the user. The power source can be a rechargeable battery. In one embodiment, for a rechargeable battery, it can be integrated in the piece of clothing, with its charging port exposed. The user can charge the battery on the road. For example, if the user is driving, the user can use a cigarette-lighter type charger to recharge the battery. In yet another embodiment, the power source is a fuel cell. The cell can be a cartridge of fuel, such methanol.

A number of embodiments have been described where the wireless communication system is a phone, particularly a cell phone that can be operated hands-free. In one embodiment, such can be considered a hands-free mode phone. FIG. 11A shows one embodiment where the phone can alternatively be a dual-mode phone. In a normal-mode phone, the audio signals are produced directly from a speaker integral with the phone (e.g., within its housing). Such a speaker is normally substantially non-directional (i.e., the speaker does not generate audio signals through transforming ultrasonic signals in air). In a dual mode phone, one mode is the hands-free mode phone as described above, and the other mode is the normal-mode phone.

The mode selection process can be set by a switch on the phone. In one embodiment, mode selection can be automatic. FIG. 11B shows examples of different techniques to automatically select the mode of a dual mode phone. For example, if the phone is attached to the clothing, the directional speaker of the interface unit can be automatically activated, and the phone becomes the hands-free mode phone. In one embodiment, automatic activation can be achieved through a switch integrated to the phone. The switch can be a magnetically-activated switch. For example, when the interface unit is attached to clothing (for hands-free usage), a magnet or a piece of magnetizable material in the clothing can cause the phone to operate in the hands-free

mode. When the phone is detached from clothing, the magnetically-activated switch can cause the phone to operate as a normal-mode phone. In another example, the switch can be mechanical. For example, an on/off button on the unit can be mechanically activated if the unit is attached. This can be done, for example, by a lever such that when the unit is attached, the lever will be automatically pressed. In yet another example, activation can be based on orientation. If the interface unit is substantially in a horizontal orientation (e.g., within 30 degrees from the horizontal), the phone will operate in the hands-free mode. However, if the unit is substantially in a vertical orientation (e.g., within 45 degrees from the vertical), the phone will operate as a normal-mode phone. A gyro in the interface unit can be used to determine the orientation of the interface unit.

A number of embodiments have been described where the wireless communication system is a phone with a directional speaker and a microphone. However, the present invention can be applied to other areas. FIG. 12 shows examples of other embodiments of the interface unit, and FIG. 13 shows examples of additional applications.

The interface unit can have two speakers, each propagating its directional audio signals towards one of the ears of the user. For example, one speaker can be on one shoulder of the user, and the other speaker on the other shoulder. The two speakers can provide a stereo effect for the user.

A number of embodiments have been described where the microphone and the speaker are integrated together in a single package. In another embodiment, the microphone can be a separate component and can be attached to the clothing as well. For wired connections, the wires from the base unit can connect to the speaker and at least one wire can split off and connect to the microphone at a location close to the head of the user.

The interface unit does not need to include a microphone. Such a wireless communication system can be used as an audio unit, such as a MP3 player, a CD player or a radio. Such wireless communication systems can be considered one-way communication systems.

In another embodiment, the interface unit can be used as the audio output, such as for a stereo system, television or a video game player. For example, the user can be playing a video game. Instead of having the audio signals transmitted by a normal speaker, the audio signals, or a representation of the audio signals, are transmitted wirelessly to a base unit or an interface unit. Then, the user can hear the audio signals in a directional manner, reducing the chance of annoying or disturbing people in his immediate environment.

In another embodiment, a wireless communication system can, for example, be used as a hearing aid. The microphone in the interface unit can capture audio signals in its vicinity, and the directional speaker can re-transmit the captured audio signals to the user. The microphone can also be a directional microphone that is more sensitive to audio signals in selective directions, such as in front of the user. In this application, the speaker output volume is typically higher. For example, one approach is to drive a bimorph device at higher voltages. The hearing aid can selectively amplify different audio frequencies by different amounts based on user preference or user hearing characteristics. In other words, the audio output can be tailored to the hearing of the user. Different embodiments on hearing enhancement through personalizing or tailoring to the hearing of the user have been described in the U.S. patent application Ser. No. 10/826,527, filed Apr. 15, 2004 now U.S. Pat. No. 7,388,962 and U.S. patent application Ser. No. 12/157,092 filed Jun. 6,

2008, and entitled, "Directional Hearing Enhancement Systems", which are hereby incorporated herein by reference.

In one embodiment, the wireless communication system can function both as a hearing aid and a cell phone. When there are no incoming calls, the system functions as a hearing aid. On the other hand, when there is an incoming call, instead of capturing audio signals in its vicinity, the system transmits the incoming call through the directional speaker to be received by the user. In another embodiment, the base unit and the interface unit are integrated together in a package, which again can be attached to the clothing by techniques previously described for the interface unit.

In yet another embodiment, an interface unit can include a monitor or a display. A user can watch television or video signals in public, again with reduced possibility of disturbing people in the immediate surroundings because the audio signals are directional. For wireless applications, video signals can be transmitted from the base unit to the interface unit through UWB signals.

The base unit can also include the capability to serve as a computation system, such as in a personal digital assistant (PDA) or a notebook computer. For example, as a user is working on the computation system for various tasks, the user can simultaneously communicate with another person in a hands-free manner using the interface unit, without the need to take her hands off the computation system. Data generated by a software application the user is working on using the computation system can be transmitted digitally with the voice signals to a remote device (e.g., another base station or unit). In this embodiment, the directional speaker does not have to be integrated or attached to the clothing of the user. Instead, the speaker can be integrated or attached to the computation system, and the computation can function as a cell phone. Directional audio signals from the phone call can be generated for the user while the user is still able to manipulate the computation system with both of his hands. The user can simultaneously make phone calls and use the computation system. In yet another approach for this embodiment, the computation system is also enabled to be connected wirelessly to a local area network, such as to a WiFi or WLAN network, which allows high-speed data as well as voice communication with the network. For example, the user can make voice over IP calls. In one embodiment, the high-speed data as well as voice communication permits signals to be transmitted wirelessly at frequencies beyond 1 GHz.

In yet another embodiment, the wireless communication system can be a personalized wireless communication system. The audio signals can be personalized to the hearing characteristics of the user of the system. The personalization process can be done periodically, such as once every year, similar to periodic re-calibration. Such re-calibration can be done by another device, and the results can be stored in a memory device. The memory device can be a removable media card, which can be inserted into the wireless communication system to personalize the amplification characteristics of the directional speaker as a function of frequency. The system can also include an equalizer that allows the user to personalize the amplitude of the speaker audio signals as a function of frequency.

The system can also be personalized based on the noise level in the vicinity of the user. The device can sense the noise level in its immediate vicinity and change the amplitude characteristics of the audio signals as a function of noise level.

The form factor of the interface unit can be quite compact. In one embodiment, it is rectangular in shape. For example,

it can have a width of about "x", a length of about "2x", and a thickness that is less than "x". "X" can be 1.5 inches, or less than 3 inches. In another example, the interface unit has a thickness of less than 1 inch. In yet another example, the interface unit does not have to be flat. It can have a curvature to conform to the physical profile of the user.

A number of embodiments have been described with the speaker being directional. In one embodiment, a speaker is considered directional if the FWHM of its ultrasonic signals is less than about 1 radian or around 57 degrees. In another embodiment, a speaker is considered directional if the FWHM of its ultrasonic signals is less than about 30 degrees. In yet another embodiment, a speaker is transmitting from, such as, the shoulder of the user. The speaker is considered directional if in the vicinity of the user's ear or in the vicinity 6-8 inches away from the speaker, 75% of the power of its audio signals is within an area of less than 50 square inches. In a further embodiment, a speaker is considered directional if in the vicinity of the ear or in the vicinity a number of inches, such as 8 inches, away from the speaker, 75% of the power of its audio signals is within an area of less than 20 square inches. In yet a further embodiment, a speaker is considered directional if in the vicinity of the ear or in the vicinity a number of inches, such as 8 inches, away from the speaker, 75% of the power of its audio signals is within an area of less than 13 square inches.

Also, referring back to FIG. 6, in one embodiment, a speaker can be considered a directional speaker if most of the power of its audio signals is propagating in one general direction, confined within a cone, such as the cone 108 in FIG. 6, and the angle between the two sides or edges of the cone, such as shown in FIG. 6, is less than 60 degrees. In another embodiment, the angle between the two sides or edges of the cone is less than 45 degrees.

In a number of embodiments described above, the directional speaker generates ultrasonic signals in the range of 40 kHz. One of the reasons to pick such a frequency is for power efficiency. However, to reduce leakage, cross talk or to enhance privacy, in other embodiments, the ultrasonic signals utilized can be between 200 kHz to 1 MHz. It can be generated by multilayer piezoelectric thin films, or other types of solid state devices. Since the carrier frequency is at a higher frequency range than 40 kHz, the absorption/attenuation coefficient by air is considerably higher. For example, at 500 kHz, in one calculation, the attenuation coefficient α can be about 4.6, implying that the ultrasonic wave will be attenuated by $\exp(-\alpha \cdot z)$ or about 40 dB/m. As a result, the waves are more quickly attenuated, reducing the range of operation of the speaker in the propagation direction of the ultrasonic waves. On the other hand, privacy is enhanced and audible interference to others is reduced.

The 500 kHz embodiment can be useful in a confined environment, such as inside a car. The beam can emit from the dashboard towards the ceiling of the car. In one embodiment, there can be a reflector at the ceiling to reflect the beam to the desired direction or location. In another embodiment, the beam can be further confined in a cavity or waveguide, such as a tube, inside the car. The beam goes through some distance inside the cavity, such as 2 feet, before emitting into free space within the car, and then received by a person, without the need for a reflector.

A number of embodiments of directional speakers have also been described where the resultant propagation direction of the ultrasonic waves is not orthogonal to the horizontal, but at, for example, 45 degrees. The ultrasonic waves can be at an angle so that the main beam of the waves is approximately pointed at an ear of the user. In another

embodiment, the propagation direction of the ultrasonic waves can be approximately orthogonal to the horizontal. Such a speaker does not have to be on a wedge or a step. It can be on a surface that is substantially parallel to the horizontal. For example, the speaker can be on the shoulder of a user, and the ultrasonic waves propagate upwards, instead of at an angle pointed at an ear of the user. If the ultrasonic power is sufficient, the waves would have sufficient acoustic power even when the speaker is not pointing exactly at the ear.

One approach to explain the sufficiency in acoustic power is that the ultrasonic speaker generates virtual sources in the direction of propagation. These virtual sources generate secondary acoustic signals in numerous directions, not just along the propagation direction. This is similar to the antenna pattern which gives non-zero intensity in numerous directions away from the direction of propagation. In one such embodiment, the acoustic power is calculated to be from 45 to 50 dB SPL if (a) the ultrasonic carrier frequency is 500 kHz; (b) the audio frequency is 1 kHz; (c) the emitter size of the speaker is 3 cm \times 3 cm; (d) the emitter power (peak) is 140 dB SPL; (e) the emitter is positioned at 10 to 15 cm away from the ear, such as located on the shoulder of the user; and (f) with the ultrasonic beam pointing upwards, not towards the ear, the center of the ultrasonic beam is about 2-5 cm away from the ear.

In one embodiment, the ultrasonic beam is considered directed towards the ear as long as any portion of the beam, or the cone of the beam, is immediately proximate to, such as within 7 cm of, the ear. The direction of the beam does not have to be pointed at the ear. It can even be orthogonal to the ear, such as propagating up from one's shoulder, substantially parallel to the face of the person.

In yet another embodiment, the emitting surface of the ultrasonic speaker does not have to be flat. It can be designed to be concave or convex to eventually create a diverging ultrasonic beam. For example, if the focal length of a convex surface is f , the power of the ultrasonic beam would be 6 dB down at a distance of f from the emitting surface. To illustrate numerically, if f is equal to 5 cm, then after 50 cm, the ultrasonic signal would be attenuated by 20 dB.

A number of embodiments have been described where a device is attachable to the clothing worn by a user. In one embodiment, attachable to the clothing worn by a user includes wearable by the user. For example, the user can wear a speaker on his neck, like a pendant on a necklace. This also would be considered as attachable to the clothing worn by the user. From another perspective, the necklace can be considered as the "clothing" worn by the user, and the device is attachable to the necklace.

One or more of the above-described embodiments can be combined. For example, two directional speakers can be positioned one on each side of a notebook computer. As the user is playing games on the notebook computer, the user can communicate with other players using the microphone on the notebook computer and the directional speakers, again without taking his hands off a keyboard or a game console. Since the speakers are directional, audio signals are more confined to be directed to the user in front of the notebook computer.

As described above, different embodiments can have at least two speakers, one ultrasonic speaker and one standard (non-ultrasonic) speaker. FIG. 14 shows such a speaker arrangement 500 according to one embodiment. In one embodiment, the speaker arrangement 500 includes at least one ultrasonic speaker 504 and at least one standard speaker 506. The ultrasonic speaker 504 can be configured to gen-

erate ultrasonic output signals $v(t)$. The ultrasonic output signals $v(t)$ can be transformed via a non-linear media, such as air, into ultrasonic-transformed audio output signals $O_1(t)$. The standard speaker 506 can be a speaker that generates standard audio output signals $O_2(t)$.

A standard speaker 506 can be audio signals (or audio sound) generated directly from the speaker 506 without the need for non-linear transformation of ultrasonic signals. For example, the standard speaker 506 can be an audio speaker. As one example, a standard speaker can be a speaker that is configured to output signals in the audio frequency range. As another example, a standard speaker can be a speaker that is configured to not generate ultrasonic frequencies. As yet another example, a standard speaker can be a speaker that is configured to not respond to ultrasonic frequency excitation at its input.

In one approach, the speaker arrangement 500 with both speakers 504 and 506 can be embodied in a portable unit, which can be made suitable for portable or wearable applications. The portable unit can be placed near a user's shoulder, with its resulting audio outputs configured to be directed to one of the ears of the user. FIG. 15 shows one example of such a wearable device 520. In another approach, the speaker arrangement 500 with both speakers 504 and 506 can be embodied in a stationary unit, such as an entertainment unit, or can in general be stationary, such as mounted to a stationary object, like on a wall.

In one embodiment, the embodiment shown in FIG. 14 can also include a number of signal processing mechanisms. In one embodiment, audio input signals $g(t)$ can be separated into two sectors (or ranges), a high frequency sector and a low frequency sector. The ultrasonic speaker 504 can be responsible for the high frequency sector, while the standard speaker 506 can be responsible for the low frequency sector. The high frequency sector of the audio input signals $g(t)$ can be pre-processed by a pre-processor or a pre-processing compensator 502 to generate pre-processed signals $s(t)$. The pre-processed signals $s(t)$ can be used to modulate ultrasonic carrier signals $u(t)$. The modulated ultrasonic signals can serve as inputs to the ultrasonic speaker 504 to produce ultrasonic output signals $v(t)$. In one embodiment, the ultrasonic carrier signals $u(t)$ can be represented as $\sin(2\pi f_c t)$. The ultrasonic output signals $v(t)$ are relatively directionally constrained as they propagate, such as, in air. Also, as they propagate, the ultrasonic output signals $v(t)$ can be self-demodulated into ultrasonic-transformed audio output signals $O_1(t)$.

In one embodiment, the pre-processing compensator 502 can be configured to enhance signal quality by, for example, compensating for at least some of the non-linear distortion effect in the ultrasonic-transformed audio output signals $O_1(t)$. An example of a pre-processing scheme is Single-Side Band (SSB) modulation. A number of other pre-processing schemes or compensation schemes have previously been described above.

Self-demodulation process in air of the ultrasonic output signals $v(t)$ can lead to a -12 dB/octave roll-off. With air being a weak non-linear medium, one approach to compensate for the roll-off is to increase the signal power, such as the power of the audio input signals $g(t)$ or the input power to the ultrasonic speaker 504. In one embodiment, the ultrasonic speaker 104 can have a relatively small aperture. For example, the aperture can be approximately circular, with a diameter in the order of a few centimeters, such as 5 cm. One way to provide higher ultrasonic power is to use a larger aperture for the ultrasonic speaker 504.

During self-demodulation, if the ultrasonic-transformed audio output signals $O_1(t)$ include signals in the low frequency sector, those signals typically can be significantly attenuated, which can cause pronounced loss of fidelity in the signals. One way to compensate for such loss can be to significantly increase the power in the low frequency sector of the audio input signals $g(t)$, or the pre-processed signals $s(t)$. But such high input power can drive the ultrasonic speaker **504** into saturation.

In one embodiment shown in FIG. **14**, the speaker arrangement **500** can include a pre-processing compensator **502** configured to apply to the high frequency sector of the audio input signals $g(t)$, but not to the low frequency sector of the audio input signals $g(t)$. In one embodiment, the pre-processing compensator **502** can substantially block or filter signals in the low frequency sector, such that they are not subsequently generated via self-demodulation in air. In another embodiment, a filter **501** can filter the audio input signals $g(t)$ such that signals in the high frequency sector can be substantially channeled to the pre-processing compensator **502** and signals in the low frequency sector can be substantially channeled to the standard speaker **506**.

In one embodiment, the standard speaker **506** can be responsible for generating the audio output signals in the low frequency sector. Since a standard speaker **506** is typically more efficient (i.e., better power efficiency) than an ultrasonic speaker, particularly, in some instances, in generating signals in the low frequency sector, power efficiency of the speaker arrangement can be significantly improved, with the operating time of the power source correspondingly increased.

In one embodiment, the speaker arrangement **500** can optionally provide a distortion compensation unit **508** to provide additional distortion compensation circuitry. FIG. **14** shows another embodiment where the standard speaker **506** can also generate signals to further compensate for distortion in the ultrasonic-transformed audio output signals $O_1(t)$. This embodiment can include a feedback mechanism. In one embodiment of this approach, a distortion compensation unit **508** can try to simulate the non-linear distortion effect due to self-demodulation in air. For example, the distortion compensation unit **508** can include differentiating electronics to twice differentiate the pre-processed signals $s(t)$ to generate the distortion compensated signals $d(t)$. The distortion compensated signals $d(t)$ can then be subtracted from the audio input signals $g(t)$ by a combiner **510**. The output from the combiner **510** (the subtracted signals) can serve as inputs to the standard audio speaker **506**. For such an embodiment, distortion in the ultrasonic-transformed audio output signals $O_1(t)$, in principle, can be significantly (or even completely) cancelled by the corresponding output in the standard audio output signals $O_2(t)$. Thus, with the assistance of the distortion compensation unit **508**, signal distortion due to the non-linear effect, in principle, can be significantly or even completely compensated, despite the difficult non-linear self-demodulation process.

One embodiment produces directional audio output signals without the need of a filter to separate the audio input signals $g(t)$ into low frequency signals and high frequency signals. The embodiment includes a pre-processor **502**, a distortion compensation unit **508**, a modulator, an ultrasonic speaker **504**, a standard audio speaker **506**, and a combiner **510**. The pre-processor **502** can be operatively connected to receive at least a portion of the audio input signals $g(t)$ and to perform predetermined preprocessing on the audio input signals to produce pre-processed signals $s(t)$. The distortion compensation unit **508** can be operatively connected to the

pre-processor **502** to produce distortion compensated signals $d(t)$ from the pre-processed signals $s(t)$. The modulator can be operatively connected to the pre-processor **502** to modulate ultrasonic carrier signals $u(t)$ by the pre-processed signals $s(t)$ thereby producing modulated ultrasonic signals. The ultrasonic speaker **504** can be operatively connected to the modulator to receive the modulated ultrasonic signals and to output ultrasonic output signals $v(t)$, which can be transformed into a first portion $O_1(t)$ of the audio output signals. The combiner **510** can be operatively connected to the distortion compensation unit **508** to subtract the distortion compensated signals $d(t)$ from at least a portion of the audio input signals $g(t)$ to generate inputs for the standard audio speaker **506** to output a second portion $O_2(t)$ of the audio output signals.

In one embodiment, digital signal processing (DSP) algorithms can be used to compute the electronics of the pre-processing compensator **502**. DSP algorithms can also be used to compute electronics in the distortion compensation unit **508** to generate the distortion compensated signals $d(t)$. Such algorithms can be used to compensate for the non-linear distortion effect in the audio output signals.

In one approach, the high frequency sector can be frequencies exceeding 500 Hz. In another embodiment, the high frequency sector can be frequencies exceeding 1 kHz.

In one embodiment, with a standard speaker being responsible for the low frequency sector and an ultrasonic speaker being responsible for the high frequency sector of the audio output signals, signals in the low frequency sector are typically more omni-directional than signals in the high frequency sector of the audio output signals. There are a number of approaches to reduce the possibility of compromising privacy due to signals in the low frequency sector being more omni-directional. In one embodiment, the standard speaker **506** can be configured to generate signals that are angularly constrained (e.g., to certain degrees), such as using a cone-shaped output device. In another embodiment, the power for the low frequency sector can be reduced. With the power intensity of the low frequency sector lowered, their corresponding audio output signals could be more difficult to discern.

Another embodiment to improve privacy is to inject into the pre-processed signals $s(t)$, some random noise-like signals. The random noise-like signals again can be used to modulate the ultrasonic carrier signals $u(t)$, and can be used as inputs to the distortion compensation unit **508**. With the random noise-like signals being injected into the signal streams, positively (to the ultrasonic speaker) and negatively (to the standard speaker), their effect would be substantially cancelled at the desired user's ear. However, for the people who would hear little or none of the ultrasonic-transformed audio output signals $O_1(t)$, but would hear outputs from the standard speaker **506**, the random noise-like signals from the standard speaker **506** would be more pronounced.

One way to represent the approximate extent of the ultrasonic-transformed audio output signals $O_1(t)$ from the ultrasonic speaker **504** is via a virtual column. It can be a fictitious column where one can hear the audio signals or audio sound. The length of the virtual column of the ultrasonic speaker **504** is typically limited by the attenuation of the ultrasonic signals in air. A lower ultrasonic frequency, such as below 40 kHz, leads to a longer (or a deeper) virtual column, while a higher ultrasonic frequency typically leads to a shorter virtual column.

In one embodiment, the ultrasonic speaker **504** can be configured to be for portable or wearable applications, where at least one of the ears of a user can be relatively close to the

speaker. For example, the speaker **504** can be attached or worn on a shoulder of the user. In this situation, the virtual column does not have to be very long, and can be restricted in length to, for example, 20 cm. This is because the distance between the shoulder and one of the user's ears is typically not much more than 20 cm. Though a higher ultrasonic frequency typically has a higher attenuation, if the virtual column can be short, the effect of a higher attenuation may not be detrimental to usability. However, a higher attenuation can improve signal isolation or privacy.

In one embodiment, a standard speaker and an ultrasonic speaker can be in a unit, and the unit further includes a RF wireless transceiver, such as a short-range wireless communication device (e.g. Bluetooth device). The transceiver can be configured to allow the unit to communicate with another device, which can be a mobile phone.

In one embodiment, the ultrasonic output signals $v(t)$ from an ultrasonic speaker can be steerable. One approach to steer uses phase array beam steering techniques.

In one embodiment, the size of a unit with both a standard speaker and an ultrasonic speaker is less than 5 cm×5 cm×1 cm, and can be operated by battery. The battery can be chargeable.

In one embodiment, an ultrasonic speaker can be implemented by at least a piezoelectric thin film transducer, a bimorph piezoelectric transducer or a magnetic film transducer.

In one embodiment, an ultrasonic speaker can be a piezoelectric transducer. The transducer includes a piezoelectric thin film, such as a polyvinylidene difluoride (PVDF) film, deposited on a plate with a number of cylindrical tubes to create mechanical resonances. The film can be attached to the perimeter of the plate of tubes and can be biased by electrodes. Appropriate voltages applied via the electrodes to the piezoelectric thin film can create vibrations of the thin film, which in turn can generate modulated ultrasonic signals.

In another embodiment, the ultrasonic speaker can be a magnetic film transducer, which includes a magnetic coil thin film transducer with a permanent magnet. The thin film can vibrate up to 0.5 mm, which can be higher in magnitude than a piezoelectric thin film transducer.

In one embodiment, a unit with a standard speaker and an ultrasonic speaker, similar to the different embodiments as disclosed herein, can be configured to be used for a directional hearing enhancement system. Different embodiments have been described regarding a hearing enhancement system in U.S. patent application Ser. No. 10/826,527, filed Apr. 15, 2004, and entitled, "DIRECTIONAL HEARING ENHANCEMENT SYSTEMS," which is hereby incorporated herein by reference.

In one embodiment, a unit with a standard speaker and an ultrasonic speaker, similar to the different embodiments as disclosed herein, can be configured to be used for a portable electronic device. Different embodiments have been described regarding a portable electronic device in U.S. patent application Ser. No. 10/826,531, filed Apr. 15, 2004, and entitled, "DIRECTIONAL SPEAKER FOR PORTABLE ELECTRONIC DEVICE," which is hereby incorporated herein by reference.

In one embodiment, a unit with a standard speaker and an ultrasonic speaker, similar to the different embodiments as disclosed herein, can be configured to be used for localized delivery of audio sound. Different embodiments have been described regarding localized delivery of audio sound in U.S. patent application Ser. No. 10/826,537, filed Apr. 15, 2004, and entitled, "METHOD AND APPARATUS FOR

LOCALIZED DELIVERY OF AUDIO SOUND FOR ENHANCED PRIVACY," which is hereby incorporated herein by reference.

In one embodiment, a unit with a standard speaker and an ultrasonic speaker, similar to the different embodiments as disclosed herein, can be configured to be used for wireless audio delivery. Different embodiments have been described regarding wireless audio delivery in U.S. patent application Ser. No. 10/826,528, filed Apr. 15, 2004, and entitled, "METHOD AND APPARATUS FOR WIRELESS AUDIO DELIVERY," which is hereby incorporated herein by reference.

FIG. 16 is a block diagram of a directional audio delivery device **1220** according to an embodiment of the invention.

The directional audio delivery device **1220** includes audio conversion circuitry **1222**, a beam-attribute control unit **1224** and a directional speaker **1226**. The audio conversion circuitry **1222** converts the received audio signals into ultrasonic signals. The directional speaker **1226** receives the ultrasonic signals and produces an audio output. The beam-attribute control unit **1224** controls one or more attributes of the audio output.

One attribute can be the beam direction. The beam-attribute control unit **1224** receives a beam attribute input, which in this example is related to the direction of the beam. This can be known as a direction input. The direction input provides information to the beam-attribute control unit **1224** pertaining to a propagation direction of the ultrasonic output produced by the directional speaker **1226**. The direction input can be a position reference, such as a position for the directional speaker **1226** (relative to its housing), the position of a person desirous of hearing the audio sound, or the position of an external electronic device (e.g., remote controller). Hence, the beam-attribute control unit **1224** receives the direction input and determines the direction of the audio output.

Another attribute can be the desired distance to be traveled by the beam. This can be known as a distance input. In one embodiment, the ultrasonic frequency of the audio output can be adjusted. By controlling the ultrasonic frequency, the desired distance traveled by the beam can be adjusted. This will be further explained below. Thus, with the appropriate control signals, the directional speaker **1226** generates the desired audio output accordingly.

One way to control the audio output level to be received by other users is through the distance input. By controlling the distance the ultrasonic output travels, the directional audio delivery device can minimize the audio output that might reach other persons.

FIG. 17 is a flow diagram of directional audio delivery processing **1400** according to an embodiment of the invention. The directional audio delivery processing **1400** is, for example, performed by a directional audio delivery device. More particularly, the directional audio delivery processing **1400** is particularly suitable for use by the directional audio delivery device **1220** illustrated in FIG. 16.

The directional audio delivery processing **1400** initially receives **1402** audio signals for directional delivery. The audio signals can be supplied by an audio system. In addition, a beam attribute input is received **1404**. As previously noted, the beam attribute input is a reference or indication of one or more attributes regarding the audio output to be delivered. After the beam attribute input has been received **1404**, one or more attributes of the beam are determined **1406** based on the attribute input. If the attribute pertains to the direction of the beam, the input can set the constrained delivery direction of the beam. The constrained

delivery direction is the direction that the output is delivered. The audio signals that were received are converted **1408** to ultrasonic signals with appropriate attributes, which may include one or more of the determined attributes. Finally, the directional speaker is driven **1410** to generate ultrasonic output again with appropriate attributes. In the case where the direction of the beam is set, the ultrasonic output is directed in the constrained delivery direction. Following the operation **1410**, the directional audio delivery processing **1400** is complete and ends. Note that the constrained delivery direction can be altered dynamically or periodically, if so desired.

FIG. **18** shows examples of beam attributes **1500** of the constrained audio output according to the invention. These beam attributes **1500** can be provided either automatically, such as periodically, or manually, such as at the request of a user. The attributes can be for the beam-attribute control unit **1224**. One attribute, which has been previously described, is the direction **1502** of the beam. Another attribute can be the beam width **1504**. In other words, the width of the ultrasonic output can be controlled. In one embodiment, the beam width is the width of the beam at the desired position. For example, if the desired location is **10** feet directly in front of the directional audio apparatus, the beam width can be the width of the beam at that location. In another embodiment, the width **1504** of the beam is defined as the width of the beam at its full-width-half-max (FWHM) position.

The desired distance **1506** to be covered by the beam can be set. In one embodiment, the rate of attenuation of the ultrasonic output/audio output can be controlled to set the desired distance. In another embodiment, the volume or amplification of the beam can be changed to control the distance to be covered. Through controlling the desired distance, other persons in the vicinity of the person to be receiving the audio signals (but not adjacent thereto) would hear little or no sound. If sound were heard by such other persons, its sound level would have been substantially attenuated (e.g., any sound heard would be faint and likely not discernable).

There are also other types of beam attribute inputs. For example, the inputs can be the position **1508**, and the size **1510** of the beam. The position input can pertain to the position of a person desirous of hearing the audio sound, or the position of an electronic device (e.g., remote controller). Hence, the beam-attribute control unit **1224** receives the beam position input and the beam size input, and then determines how to drive the directional speaker to output the audio sound to a specific position with the appropriate beam width. Then, the beam-attribute control unit **1224** produces drive signals, such as ultrasonic signals and other control signals. The drive signals controls the directional speaker to generate the ultrasonic output towards a certain position with a particular beam size.

There can be more than one beam. Hence, one attribute of the beam is the number **1512** of beams present. Multiple beams can be utilized, such that multiple persons are able to receive the audio signals via the ultrasonic output by the directional speaker (or a plurality of directional speakers). Each beam can have its own attributes.

There can also be a dual mode operation **1514** having a directional mode and a normal mode. The directional audio apparatus can include a normal speaker (e.g., substantially omni-directional speaker). There are situations where a user would prefer the audio output to be heard by every one in a room, for example. Under this situation, the user can deactivate the directional delivery mechanism of the apparatus,

or can allow the directional audio apparatus to channel the audio signals to the normal speaker to generate the audio output. In one embodiment, a normal speaker generates its audio output based on audio signals, without the need for generating ultrasonic outputs. However, a directional speaker requires ultrasonic signals to generate its audio output.

In one embodiment, the beam from a directional speaker can propagate towards the ceiling of a building, which reflects the beam back towards the floor to be received by users. One advantage of such an embodiment is to lengthen the propagation distance to broaden the width of the beam when it reaches the users. Another feature of this embodiment is that the users do not have to be in the line-of-sight of the directional audio apparatus.

FIG. **19** is a flow diagram of directional audio delivery processing **1700** according to another embodiment of the invention. The directional audio delivery processing **1700** is, for example, performed by a directional audio delivery device. More particularly, the directional audio delivery processing **1700** is particularly suitable for use by the directional audio delivery device **1220** illustrated in FIG. **16**.

The directional audio delivery processing **1700** receives **1702** audio signals for directional delivery. The audio signals are provided by an audio system. In addition, two beam attribute inputs are received, and they are a position input **1704** and a beam size input **1706**. Next, the directional audio delivery processing **1700** determines **1708** a delivery direction and a beam size based on the position input and the beam size input. The desired distance to be covered by the beam can also be determined. The audio signals are then converted **1710** to ultrasonic signals, with the appropriate attributes. For example, the frequency and/or the power level of the ultrasonic signals can be generated to set the desired travel distance of the beam. Thereafter, a directional speaker (e.g., ultrasonic speaker) is driven **1712** to generate ultrasonic output in accordance with, for example, the delivery direction and the beam size. In other words, when driven **1712**, the directional speaker produces ultrasonic output (that carries the audio sound) towards a certain position, with a certain beam size at that position. In one embodiment, the ultrasonic signals are dependent on the audio signals, and the delivery direction and the beam size are used to control the directional speaker. In another embodiment, the ultrasonic signals can be dependent on not only the audio signals but also the delivery direction and the beam size. Following the operation **1712**, the directional audio delivery processing **1700** is complete and ends.

FIG. **20A** is a flow diagram of directional audio delivery processing **1800** according to yet another embodiment of the invention. The directional audio delivery processing **1800** is, for example, suitable for use by a directional audio delivery device. More particularly, the directional audio delivery processing **1800** is particularly suitable for use by the directional audio delivery device **1220** illustrated in FIG. **16**, with the beam attribute inputs being beam position and beam size received from a remote device.

The directional audio delivery processing **1800** initially activates a directional audio apparatus that is capable of constrained directional delivery of audio sound. A decision **1804** determines whether a beam attribute input has been received. Here, in accordance with one embodiment, the audio apparatus has associated with it a remote control device, and the remote control device can provide the beam attributes. Typically, the remote control device enables a user positioned remotely (e.g., but in line-of-sight) to change settings or characteristics of the audio apparatus. One beam

attribute is the desired location of the beam. Another attribute is the beam size. According to the invention, a user of the audio apparatus might hold the remote control device and signal to the directional audio apparatus a position reference. This can be done by the user, for example, through selecting a button on the remote control device. This button can be the same button for setting the beam size because in transmitting beam size information, location signals can be relayed as well. The beam size can be signaled in a variety of ways, such as via a button, dial or key press, using the remote control device. When the decision **1804** determines that no attributes have been received from the remote control device, the decision **1804** can just wait for an input.

When the decision **1804** determines that a beam attribute input has been received from the remote control device, control signals for the directional speaker are determined **1806** based on the attribute received. If the attribute is a reference position, a delivery direction can be determined based on the position reference. If the attribute is for a beam size adjustment, control signals for setting a specific beam size are determined. Then, based on the control signals determined, the desired ultrasonic output that is constrained is produced **1812**.

Next, a decision **1814** determines whether there are additional attribute inputs. For example, an additional attribute input can be provided to incrementally increase or decrease the beam size. The user can adjust the beam size, hear the effect and then further adjust it, in an iterative manner. When the decision **1814** determines that there are additional attribute inputs, appropriate control signals are determined **1806** to adjust the ultrasonic output accordingly. When the decision **1814** determines that there are no additional inputs, the directional audio apparatus can be deactivated. When the decision **1816** determines that the audio system is not to be deactivated, then the directional audio delivery processing **1800** returns to continuously output the constrained audio output. On the other hand, when the decision **1816** determines that the directional audio apparatus is to be deactivated, then the directional audio delivery processing **1800** is complete and ends.

Besides directionally constraining audio sound that is to be delivered to a user, the audio sound can optionally be additionally altered or modified in view of the user's hearing characteristics or preferences, or in view of the audio conditions in the vicinity of the user.

FIG. **20B** is a flow diagram of an environmental accommodation process **1840** according to one embodiment of the invention. The environmental accommodation process **1840** determines **1842** environmental characteristics. In one implementation, the environmental characteristics can pertain to measured sound (e.g., noise) levels at the vicinity of the user. The sound levels can be measured by a pickup device (e.g., microphone) at the vicinity of the user. The pickup device can be at the remote device held by the user. In another implementation, the environmental characteristics can pertain to estimated sound (e.g., noise) levels at the vicinity of the user. The sound levels at the vicinity of the user can be estimated based on a position of the user/device and/or the estimated sound level for the particular environment. For example, sound level in a department store is higher than the sound level in the wilderness. The position of the user can, for example, be determined by Global Positioning System (GPS) or other triangulation techniques, such as based on infrared, radio-frequency or ultrasound frequencies with at least three non-collinear receiving points. There can be a database with information regarding

typical sound levels at different locations. The database can be accessed to retrieve the estimated sound level based on the specific location.

After the environmental accommodation process **1840** determines **1842** the environmental characteristics, the audio signals are modified based on the environmental characteristics. For example, if the user were in an area with a lot of noise (e.g., ambient noise), such as at a confined space with various persons or where construction noise is present, the audio signals could be processed to attempt to suppress the unwanted noise, and/or the audio signals (e.g., in a desired frequency range) could be amplified. One approach to suppress the unwanted noise is to introduce audio outputs that are opposite in phase to the unwanted noise so as to cancel the noise. In the case of amplification, if noise levels are excessive, the audio output might not be amplified to cover the noise because the user might not be able to safely hear the desired audio output. In other words, there can be a limit to the amount of amplification and there can be negative amplification on the audio output (even complete blockage) when excessive noise levels are present. Noise suppression and amplification can be achieved through conventional digital signal processing, amplification and/or filtering techniques. The environmental accommodation process **1840** can, for example, be performed periodically or if there is a break in audio signals for more than a preset amount of time. The break may signify that there is a new audio stream.

A user might have a hearing profile that contains the user's hearing characteristics. The audio sound provided to the user can optionally be customized or personalized to the user by altering or modifying the audio signals in view of the user's hearing characteristics. By customizing or personalizing the audio signals to the user, the audio output can be enhanced for the benefit or enjoyment of the user.

FIG. **20C** is a flow diagram of an audio personalization process **1860** according to one embodiment of the invention. The audio personalization process **1860** retrieves **1862** an audio profile associated with the user. The hearing profile contains information that specifies the user's hearing characteristics. For example, the hearing characteristics may have been acquired by the user taking a hearing test. Then, the audio signals are modified **1864** or pre-processed based on the audio profile associated with the user.

The hearing profile can be supplied to a directional audio delivery device performing the personalization process **1860** in a variety of different ways. For example, the audio profile can be electronically provided to the directional audio delivery device through a network. As another example, the audio profile can be provided to the directional audio delivery device by way of a removable data storage device (e.g., memory card). Additional details on audio profiles and personalization to enhance hearing can be found in U.S. Patent Application Ser. No. 19/826,527, filed Apr. 15, 2004, now U.S. Pat. No. 7,388,962, entitled "DIRECTIONAL HEARING ENHANCEMENT SYSTEMS", which is hereby incorporated herein by reference.

The environmental accommodation process **1840** and/or the audio personalization process **1860** can optionally be performed together with any of the directional audio delivery devices or processes discussed above. For example, the environmental accommodation process **1840** and/or the audio personalization process **1860** can optionally be performed together with any of the directional audio delivery processes **1400**, **1700** or **1800** embodiments discussed above with respect to FIGS. **17**, **19** and **20**. The environmental accommodation process **1840** and/or the audio personaliza-

tion process **1860** typically would precede the operation **1408** in FIG. 17, the operation **1710** in FIG. 19 and/or the operation **1812** in FIG. 20A.

FIG. 21A is a perspective diagram of an ultrasonic transducer **1900** according to one embodiment of the invention. The ultrasonic transducer **1900** can implement the directional speakers discussed herein. The ultrasonic transducer **1900** produces the ultrasonic output utilized as noted above. In one embodiment, the ultrasonic transducer **1900** includes a plurality of resonating tubes **1902** covered by a piezoelectric thin-film, such as PVDF, that is under tension. When the film is driven by a voltage at specific frequencies, the structure will resonate to produce the ultrasonic output.

Mathematically, the resonance frequency f of each eigen mode (n,s) of a circular membrane can be represented by:

$$f_{(n,s)} = \alpha_{(n,s)} / (2\pi a) * \sqrt{S/m}$$

where

a is the radius of the circular membrane,

S is the uniform tension per unit length of boundary, and

M is the mass of the membrane per unit area.

For different eigen modes of the tube structure shown in FIG. 21A,

$$\alpha_{(0,0)} = 2.4$$

$$\alpha_{(0,1)} = 5.52$$

$$\alpha_{(0,2)} = 8.65$$

...

Assume $\alpha_{(0,0)}$ to be the fundamental resonance frequency, and is set to be at 50 kHz. Then, $\alpha_{(0,1)}$ is 115 kHz, and $\alpha_{(0,2)}$ is 180 kHz etc. The $n=0$ modes are all axisymmetric modes. In one embodiment, by driving the thin-film at the appropriate frequency, such as at any of the axisymmetric mode frequencies, the structure resonates, generating ultrasonic waves at that frequency.

Instead of using a membrane over the resonating tubes, in another embodiment, the ultrasonic transducer is made of a number of speaker elements, such as unimorph, bimorph or other types of multilayer piezoelectric emitting elements. The elements can be mounted on a solid surface to form an array. These emitters can operate at a wide continuous range of frequencies, such as from 40 to 200 kHz.

One embodiment to control the distance of propagation of the ultrasonic output is by changing the carrier frequency, such as from 40 to 200 kHz. Frequencies in the range of 200 kHz have much higher acoustic attenuation in air than frequencies around 40 kHz. Thus, the ultrasonic output can be attenuated at a much faster rate at higher frequencies, reducing the potential risk of ultrasonic hazard to health, if any. Note that the degree of attenuation can be changed continuously, such as based on multi-layer piezoelectric thin-film devices by continuously changing the carrier frequency. In another embodiment, the degree of isolation can be changed more discreetly, such as going from one eigen mode to another eigen mode of the tube resonators with piezoelectric membranes.

FIG. 21B is a diagram that illustrates the ultrasonic transducer **1900** generating its beam **1904** of ultrasonic output.

The width of the beam **1904** can be varied in a variety of different ways. For example, a reduced area or one segment of the transducer **1900** can be used to decrease the width of the beam **1904**. In the case of a membrane over resonating tubes, there can be two concentric membranes, an inner one **1910** and an outer one **1912**, as shown in FIG. 21C. One can turn on the inner one only, or both at the same time with the same frequency, to control the beam width. FIG. 21D illustrates another embodiment **1914**, with the transducer segmented into four quadrants. The membrane for each

quadrant can be individually controlled. They can be turned on individually, or in any combination to control the width of the beam. In the case of directional speakers using an array of bimorph elements, reduction of the number of elements can be used to reduce the size of the beam width. Another approach is to activate elements within specific segments to control the beam width.

In yet another embodiment, the width of the beam can be broadened by increasing the frequency of the ultrasonic output. To illustrate this embodiment, the dimensions of the directional speaker are made to be much larger than the ultrasonic wavelengths. As a result, beam divergence based on aperture diffraction is relatively small. One reason for the increase in beam width in this embodiment is due to the increase in attenuation as a function of the ultrasonic frequency. Examples are shown in FIGS. 21E-21G, with the ultrasonic frequencies being 40 kHz, 100 kHz and 200 kHz, respectively. These figures illustrate the audio output beam patterns computed by integrating the non-linear KZK equation based on an audio frequency at 1 kHz. The emitting surface of the directional speaker is assumed to be a planar surface of 20 cm by 10 cm. Such equations are described, for example, in "Quasi-plane waves in the nonlinear acoustics of confined beams," by E. A. Zabolotskaya and R. V.K. hokhov, which appeared in *Sov. Phys. Acoust.*, Vol. 15, pp. 35-40, 1969; and "Equations of nonlinear acoustics," by V. P. Kuznetsov, which appeared in *Sov. Phys. Acoust.*, Vol. 16, pp. 467-470, 1971.

In the examples shown in FIGS. 21E-21G, the acoustic attenuations are assumed to be 0.2 per meter for 40 kHz, 0.5 per meter for 100 kHz and 1.0 per meter for 200 kHz. The beam patterns are calculated at a distance of 4 m away from the emitting surface and normal to the axis of propagation. The x-axis of the figures indicates the distance of the test point from the axis (from -2 m to 2m), while the y-axis of the figures indicates the calculated acoustic pressure in dB SPL of the audio output at the test point. The emitted power for the three examples are normalized so that the received power for the three audio outputs on-axis are roughly the same (e.g. at 56 dB SPL 4 m away). Comparing the figures, one can see that the lowest carrier frequency (40 kHz in FIG. 21E) gives the narrowest beam and the highest carrier frequency (200 kHz in FIG. 21G) gives the widest beam. One explanation can be that higher acoustic attenuation reduces the length of the virtual array of speaker elements, which tends to broaden the beam pattern. Anyway, in this embodiment, a lower carrier frequency provides better beam isolation, with privacy enhanced.

As explained, the audio output is in a constrained beam for enhanced privacy. Sometimes, although a user would not want to disturb other people in the immediate neighborhood, the user may want the beam to be wider or more divergent. A couple may be sitting together to watch a movie. Their enjoyment would be reduced if one of them cannot hear the movie because the beam is too narrow. In a number of embodiments to be described below, the width of the beam can be expanded in a controlled manner based on curved structural surfaces or other phase-modifying beam forming techniques.

FIG. 22 illustrates one approach to diverge the beam based on an ultrasonic speaker with a convex emitting surface. The surface can be structurally curved in a convex manner to produce a diverging beam. The embodiment shown in FIG. 22 has a spherical-shaped ultrasonic speaker **2000**, or an ultrasonic speaker whose emitting surface of ultrasonic output is spherical in shape. In the spherical arrangement, a spherical surface **2002** has a plurality of

ultrasonic elements **2004** affixed (e.g. bimorphs) or integral thereto. The ultrasonic speaker with a spherical surface **2002** forms a spherical emitter that outputs an ultrasonic output within a cone (or beam) **2006**. Although the cone will normally diverge due to the curvature of the spherical surface **2002**, the cone **2006** remains directionally constrained.

Diverging beams can also be generated even if the emitting surface of the ultrasonic speaker is a planar surface. For example, a convex reflector can be used to reflect the beam into a diverging beam (and thus with an increased beam width). In this embodiment, the ultrasonic speaker can be defined to include the convex reflector.

Another way to modify the shape of a beam, so as to diverge or converge the beam, is through controlling phases. In one embodiment, the directional speaker includes a number of speaker elements, such as bimorphs. The phase shifts to individual elements of the speaker can be individually controlled. With the appropriate phase shift, one can generate ultrasonic outputs with a quadratic phase wavefront to produce a converging or diverging beam. For example, the phase of each emitting element is modified by $k*r^2 / (2F_o)$, where (a) r is the radial distance of the emitting element from the point where the diverging beam seems to originate from, (b) F_o is the desired focal distance, (c) k —the propagation constant of the audio frequency f —is equal to $2\pi f / c_o$, where c_o is the acoustic velocity.

In yet another example, beam width can be changed by modifying the focal length or the focus of the beam, or by de-focusing the beam. This can be done electronically through adjusting the relative phases of the ultrasonic signals exciting different directional speaker elements.

Still further, the propagation direction of the ultrasonic beam, such as the beam **2006** in FIG. **22**, can be changed by electrical and/or mechanical mechanisms. To illustrate based on the spherical-shaped ultrasonic speaker shown in FIG. **22**, a user can physically reposition the spherical surface **2002** to change its beam's orientation or direction. Alternatively, a motor can be mechanically coupled to the spherical surface **2002** to change its orientation or the propagation direction of the ultrasonic output. In yet another embodiment, the direction of the beam can be changed electronically based on phase array techniques.

The movement of the spherical surface **2002** to adjust the delivery direction can track user movement. This tracking can be performed dynamically. This can be done through different mechanisms, such as by GPS or other triangulation techniques. The user's position is fed back to or calculated by the directional audio apparatus. The position can then become a beam attribute input. The beam-attribute control unit would convert the input into the appropriate control signals to adjust the delivery direction of the audio output. The movement of the spherical surface **2002** can also be in response to a user input. In other words, the movement or positioning of the beam **2006** can be done automatically or at the instruction of the user.

As another example, a directional speaker can be rotated to cause a change in the direction in which the directionally-constrained audio output outputs are delivered. In one embodiment, a user of an audio system can manually position (e.g., rotate) the directional speaker to adjust the delivery direction. In another embodiment, the directional speaker can be positioned (e.g., rotated) by way of an electrical motor provided within the directional speaker. Such an electrical motor can be controlled by a conventional

control circuit and can be instructed by one or more buttons provided on the directional speaker or a remote control device.

Depending on the power level of the ultrasonic signals, sometimes, it might be beneficial to reduce its level in free space to prevent any potential health hazards, if any. FIGS. **23A-23B** show two such embodiments that can be employed, for example, for such a purpose. FIG. **23A** illustrates a directional speaker with a planar emitting surface **2404** of ultrasonic output. The dimension of the planar surface can be much bigger than the wavelength of the ultrasonic signals. For example, the ultrasonic frequency is 100 kHz and the planar surface dimension is 15 cm, which is 50 times larger than the wavelength. With a much bigger dimension, the ultrasonic waves emitting from the surface are controlled so that they do not diverge significantly within the enclosure **2402**. In the example shown in FIG. **23A**, the directional audio delivery device **2400** includes an enclosure **2402** with at least two reflecting surfaces for the ultrasonic waves. The emitting surface **2404** generates the ultrasonic waves, which propagate in a beam **2406**. The beam reflects within the enclosure **2402** back and forth at least once by reflecting surfaces **2408**. After the multiple reflections, the beam emits from the enclosure at an opening **2410** as the output audio **2412**. The dimensions of the opening **2410** can be similar to the dimensions of the emitting surface **2404**. In one embodiment, the last reflecting surface can be a concave or convex surface **2414**, instead of a planar reflector, to generate, respectively, a converging or diverging beam for the output audio **2412**. Also, at the opening **2410**, there can be an ultrasonic absorber to further reduce the power level of the ultrasonic output in free space.

FIG. **23B** shows another embodiment of a directional audio delivery device **2450** that allows the ultrasonic waves to bounce back and forth at least once by ultrasonic reflecting surfaces before emitting into free space. In FIG. **23B**, the directional speaker has a concave emitting surface **2460**. The concave surface first focuses the beam and then diverges the beam. For example, the focal point **2464** of the concave surface **2460** is at the mid-point of the beam path within the enclosure. Then with the last reflecting surface **2462** being flat, convex or concave, the beam width at the opening **2466** of the enclosure can be not much larger than the beam width right at the concaved emitting surface **2460**. However, at the emitting surface **2460**, the beam is converging. While at the opening **2466**, the beam is diverging. The curvatures of the emitting and reflecting surfaces can be computed according to the desired focal length or beam divergence angle similar to techniques used in optics, such as in telescopic structures.

In one embodiment, the degree of isolation or privacy can be controlled independent of the beam width. For example, one can have a wider beam that covers a shorter distance through increasing the frequency of the ultrasonic signals. Isolation or privacy can also be controlled through, for example, (a) phase array beam forming techniques, (b) adjusting the focal point of the beam, or (c) de-focusing the beam.

The volume of the audio output can be modified through, for example, (a) changing the amplitude of the ultrasonic signals driving the directional speakers, (b) modifying the ultrasonic frequency to change its distance coverage, or (c) activating more segments of a planar or curved speaker surface.

The various embodiments, implementations and features of the invention noted above can be combined in various ways or used separately. Those skilled in the art will understand from the description that the invention can be

31

equally applied to or used in other various different settings with respect to various combinations, embodiments, implementations or features provided in the description herein.

The invention can be implemented in software, hardware or a combination of hardware and software. A number of embodiments of the invention can also be embodied as computer readable code on a computer readable medium. The computer readable medium is any data storage device that can store data, which can thereafter be read by a computer system. Examples of the computer readable medium include read-only memory, random-access memory, CD-ROMs, magnetic tape, optical data storage devices, and carrier waves. The computer readable medium can also be distributed over network-coupled computer systems so that the computer readable code is stored and executed in a distributed fashion.

Numerous specific details are set forth in order to provide a thorough understanding of the invention. However, it will be understood by those skilled in the art that the invention may be practiced without these specific details. The description and representation herein are the common meanings used by those experienced or skilled in the art to most effectively convey the substance of their work to others skilled in the art. In other instances, well-known methods, procedures, components, and circuitry have not been described in detail to avoid unnecessarily obscuring aspects of the present invention.

Also, in this specification, reference to "one embodiment" or "an embodiment" means that a particular feature, structure, or characteristic described in connection with the embodiment can be included in at least one embodiment of the invention. The appearances of the phrase "in one embodiment" in various places in the specification are not necessarily all referring to the same embodiment, nor are separate or alternative embodiments mutually exclusive of other embodiments. Further, the order of blocks in process flowcharts or diagrams representing one or more embodiments of the invention do not inherently indicate any particular order nor imply any limitations in the invention.

Other embodiments of the invention will be apparent to those skilled in the art from a consideration of this specification or practice of the invention disclosed herein. It is intended that the specification and examples be considered as exemplary only, with the true scope and spirit of the invention being indicated by the following claims.

The invention claimed is:

1. An electronic circuit for producing audio output signals from audio input signals, the audio input signals including at least low frequency signals and high frequency signals, the electronic circuit comprising:

a storage device; and
a processor coupled to the storage device, the processor to process at least the high frequency signals to produce pre-processed signals, and to produce distortion compensated signals at least based on the pre-processed signals;

wherein the electronic circuit to:

modulate ultrasonic carrier signals by the pre-processed signals to produce modulated ultrasonic signals for an ultrasonic speaker to output ultrasonic output signals to be transformed into at least a first portion of the audio output signals, the first portion of the audio output signals being directional, and modify the low frequency signals at least based on the distortion compensated signals to produce standard-

32

audio-speaker input signals for a standard audio speaker to output at least a second portion of the audio output signals.

2. An electronic circuit as recited in claim 1, wherein the electronic circuit to separate the audio input signals into at least the low frequency signals and the high frequency signals.

3. An electronic circuit as recited in claim 2, wherein the electronic circuit at least to subtract the distortion compensated signals from the low frequency signals to produce the standard-audio-speaker input signals for the standard audio speaker, and

wherein the distortion compensated signals to compensate for at least some of the non-linear distortion in the first portion of the audio output signals produced from the transformation of the ultrasonic output signals.

4. An electronic circuit as recited in claim 2, wherein the electronic circuit at least to subtract the distortion compensated signals from the low frequency signals to produce the standard-audio-speaker input signals for the standard audio speaker, and wherein the distortion compensation signals to at least substantially simulate non-linear distortion effect due to self-demodulation of ultrasonic signals in air.

5. An electronic circuit as recited in claim 2, wherein the electronic circuit at least to subtract the distortion compensated signals from the low frequency signals to produce the standard-audio-speaker input signals for the standard audio speaker, and wherein the electronic circuit to at least twice differentiate at least a portion of the pre-processed signals to produce the distortion compensated signals.

6. An electronic circuit as recited in claim 1, wherein the processor to add noise to the pre-processed signals to improve privacy.

7. An electronic circuit as recited in claim 1, wherein the electronic circuit includes wireless communication components to enable the electronic circuit for wireless communication.

8. An electronic circuit as recited in claim 1, wherein the electronic circuit includes instructions to cancel echo.

9. An electronic circuit for producing audio output signals from audio input signals, the audio input signals including at least low frequency signals and high frequency signals, the electronic circuit comprising:

a storage device to store at least instructions;
a processor coupled to the storage device, the processor to execute at least a portion of the instructions, wherein the instructions include at least instructions to process at least the high frequency signals to produce pre-processed signals, and to produce distortion compensated signals at least based on the pre-processed signals, and

wherein the electronic circuit to:

modulate ultrasonic carrier signals by the pre-processed signals to produce modulated ultrasonic signals for an ultrasonic speaker to output ultrasonic output signals to be transformed into at least a first portion of the audio output signals, the first portion of the audio output signals being directional, and modify the low frequency signals at least based on the distortion compensated signals to produce input signals for a standard audio speaker to output at least a second portion of the audio output signals.

10. An electronic circuit as recited in claim 9, wherein the processor is a digital signal processor.

33

11. An electronic circuit for producing audio output signals from audio input signals, the audio input signals including at least low frequency signals and high frequency signals, the electronic circuit comprising:

a storage device; and

a processor coupled to the storage device,

wherein the electronic circuit to:

filter the audio input signals into the low frequency signals and the high frequency signals,

modulate ultrasonic carrier signals based on signals from the high frequency signals to produce modulated ultrasonic signals for an ultrasonic speaker to output ultrasonic output signals to be transformed into at least a first portion of the audio output signals, the first portion of the audio output signals being directional, and

produce input signals based on signals from the low frequency signals for a standard audio speaker to output at least a second portion of the audio output signals.

12. An electronic circuit as recited in claim 11, wherein the processor to process at least the high frequency signals to produce pre-processed signals, and wherein the electronic circuit to modulate the ultrasonic carrier signals by the pre-processed signals to produce the modulated ultrasonic signals for the ultrasonic speaker to output the ultrasonic output signals.

13. An electronic circuit as recited in claim 12, wherein the processor to produce distortion compensated signals at least based on the pre-processed signals, and wherein the electronic circuit to modify the low frequency signals at least based on the distortion compensation signals to produce the input signals for the standard audio speaker to output at least the second portion of the audio output signals.

14. An electronic circuit as recited in claim 11, wherein the electronic circuit to have at least one of the modulated ultrasonic signals and the input signals for the standard audio speaker modified to compensate for at least some of the non-linear distortion due to the transformation of the ultrasonic output signals into the at least a first portion of the audio output signals in air.

15. An electronic circuit as recited in claim 14, wherein the ultrasonic signals have at least a frequency that is at or above 100 kHz.

16. An electronic circuit as recited in claim 14, wherein the electronic circuit is configured to be removably attachable to a mobile phone to allow the audio output signals to become audio output signals of the mobile phone.

17. An electronic circuit as recited in claim 16, wherein an attribute of the first portion of the audio output signals is a direction, and

wherein the electronic circuit is configured to electronically steer at least the direction of the first portion of the audio output signals.

18. An electronic circuit as recited in claim 17, wherein the electronic circuit is configured to allow an external device to set the direction of the first portion of the audio output signals.

19. An electronic circuit as recited in claim 18, wherein the electronic circuit is configured to allow the position of the external device to set the direction of the first portion of the audio output signals.

20. An electronic circuit as recited in claim 19, wherein the ultrasonic signals have at least a frequency that is at or above 100 kHz.

34

21. An electronic circuit as recited in claim 11, wherein the electronic circuit is configured to operate as a wireless communication system.

22. An electronic circuit as recited in claim 21, wherein the wireless communication system is configured to operate as a mobile phone.

23. An electronic circuit as recited in claim 21, wherein the wireless communication system is configured to operate as a hearing aid.

24. An electronic circuit as recited in claim in claim 22, wherein the mobile phone is configured to operate in at least a first mode and a second mode, wherein in the first mode, the mobile phone is configured to output the audio output signals, and wherein in the second mode, the mobile phone is configured to output another audio output signals that are produced from a standard audio speaker at least partially in the mobile phone, without using the ultrasonic speaker.

25. An electronic circuit as recited in claim 22, wherein the wireless communication system is also configured to operate as a hearing aid.

26. An electronic circuit as recited in claim in claim 24, wherein the mobile phone is configured to change from one mode to the other mode, from the first and the second modes, at least based on the orientation of the phone.

27. An electronic circuit as recited in claim in claim 24, wherein the mobile phone is configured to change from one mode to the other mode, from the first and the second modes, at least based on a position at the phone, with the position selectable by a user of the phone.

28. An electronic circuit as recited in claim 11, wherein an attribute of the first portion of the audio output signals is a direction, and wherein the electronic circuit is configured to electronically steer at least the direction of the first portion of the audio output signals.

29. An electronic circuit as recited in claim 28, wherein the electronic circuit is configured to allow an external device to set the direction of the first portion of the audio output signals.

30. An electronic circuit as recited in claim 29, wherein the electronic circuit is configured to allow the position of the external device to set the direction of the first portion of the audio output signals.

31. An electronic circuit as recited in claim 11 further comprising the ultrasonic speaker and the standard audio speaker.

32. An electronic circuit as recited in claim 11, wherein the electronic circuit is in a structure that includes the shape of a wedge having an angle relative to the horizontal direction, with the angle helping set the direction of at least the first portion of the audio output signals, the first portion of the audio output signals being directional.

33. An electronic circuit as recited in claim 11, wherein the standard audio speaker is a non-ultrasonic speaker.

34. An apparatus for producing audio output signals from audio input signals, the audio output signals including at least a first portion and a second portion, the apparatus comprising:

an ultrasonic speaker; and

a non-ultrasonic speaker,

wherein the ultrasonic speaker is configured to receive modulated ultrasonic signals to output ultrasonic output signals to be transformed into at least the first portion of the audio output signals, the first portion of the audio output signals being directional,

35

wherein the modulated ultrasonic signals are from modulating ultrasonic carrier signals at least based on high frequency signals,

wherein the non-ultrasonic speaker is configured to receive input signals to output at least the second portion of the audio output signals, with the input signals at least based on low frequency signals, and wherein the low frequency signals and the high frequency signals are filtered outputs of the audio input signals.

35. An apparatus for producing audio output signals from audio input signals, the audio input signals including at least low frequency signals and high frequency signals, the apparatus comprising:

a first speaker device, wherein the first speaker device includes at least:

15 circuitry to at least modify at least a portion of the high frequency signals to form modified high frequency signals;

a modulator to modulate ultrasonic signals at least based on the modified high frequency signals; and an ultrasonic speaker to output ultrasonic output signals at least based on the modulated ultrasonic signals, with the ultrasonic output signals to be transformed into at least a first portion of the audio output signals, the first portion of the audio output signals being directional,

wherein the circuitry to at least modify the at least a portion of the high frequency signals to compensate for at least some of the non-linear distortion due to the transformation of the ultrasonic output signals into the at least a first portion of the audio output signals in air, and

wherein the apparatus further comprises a filter to filter out the at least a portion of the high frequency signals from at least a portion of the audio input signals, for the circuitry to at least modify.

36. An apparatus as recited in claim 35 further comprising a second speaker device, wherein the second speaker device comprises another ultrasonic speaker to output ultrasonic output signals based on at least a portion of the audio input signals, with the ultrasonic output signals to be transformed into at least a second portion of the audio output signals, the second portion of the audio output signals being directional.

37. An apparatus as recited in claim 36, wherein, in operation, the first speaker device and the second speaker device are to be positioned separately but both in the vicinity of the neck of a user, to at least direct the first portion of the audio output signals in a direction generally toward a first ear of the user, and to at least direct the second portion of the audio output signals in a direction generally toward a second ear of the user.

38. An apparatus as recited in claim 36, wherein, in operation, the first speaker device is to be positioned in the vicinity of a first shoulder of a user, and wherein, in operation, the second speaker device is to be positioned in the vicinity of a second shoulder of the user.

36

39. An apparatus as recited in claim 35, wherein the apparatus is wearable by a user.

40. An apparatus as recited in claim 35, wherein, in operation, the first speaker device is to be positioned in the vicinity of the neck of a user to at least direct the first portion of the audio output signals in a direction generally toward a first ear of the user.

41. An apparatus as recited in claim 35, wherein, in operation, the first speaker device is to be positioned in the vicinity of a first shoulder of a user.

42. An apparatus as recited in claim 35, wherein, in operation, the first speaker device is to be worn by the user via a piece of material circling around at least a portion of the neck of a user.

43. An apparatus as recited in claim 35 further comprising a microphone.

44. An apparatus as recited in claim 35 further comprising a non-ultrasonic speaker to output at least a second portion of the audio output signals, at least based on at least a portion of the low frequency signals.

45. An apparatus as recited in claim 44, wherein, in operation, the first speaker device is to be positioned closer to a first shoulder than a second shoulder of a user.

46. An apparatus as recited in claim 44 further comprising another ultrasonic speaker to output ultrasonic output signals from at least a portion of the audio input signals to form a third portion of the audio output signals, which is directional.

47. An apparatus as recited in claim 46, wherein, in operation, the first speaker device and the another ultrasonic speaker are to be positioned separately and in the vicinity of the neck of a user, to at least direct the first portion of the audio output signals in a direction generally toward a first side of the user, and to at least direct the third portion of the audio output signals in a direction generally toward a second side of the user.

48. An apparatus as recited in claim 44 further comprising wireless communication components to enable the apparatus for wireless communication.

49. An apparatus as recited in claim 48 further comprising a microphone.

50. An apparatus as recited in claim 49 further comprising another ultrasonic speaker to output ultrasonic output signals from at least a portion of the audio input signals to form a third portion of the audio output signals, which is directional.

51. An apparatus as recited in claim 50 wherein, in operation, the first speaker device and the another ultrasonic speaker are to be positioned separately and in the vicinity of the neck of a user, to at least direct the first portion of the audio output signals in a direction generally toward a first side of the user, and to at least direct the third portion of the audio output signals in a direction generally toward a second side of the user.

* * * * *